

Clinker Coolers

U. Gasser / D. Brassel
PT 97/14232/E (Revision 1, February 1999)

1. INTRODUCTION	116
2. GENERAL CONSIDERATIONS	116
2.1 Heat Flow in a Kiln System.....	116
2.2 Definitions.....	118
2.3 Calculations.....	120
3. GRATE COOLERS	122
3.1 The Reciprocating Grate Cooler	122
3.1.1 Principle	122
3.1.2 History	124
3.1.3 Conventional Grate Coolers (1980's).....	126
3.1.4 Typical Grate Cooler Problems.....	128
3.1.5 Modern Grate Coolers (1990's)	130
3.1.6 Design Highlights of Modern Grate Coolers	132
3.1.7 Clinker Crushers.....	141
3.1.8 Cooler control	146
3.1.9 Cooler Dedusting.....	148
3.1.10 Developments	150
3.2 The Cross Bar Cooler	152
3.2.1 Principle	152
3.2.2 Main features.....	152
3.2.3 Strengths and Weaknesses	154
3.3 The Travelling Grate Cooler	156
3.3.1 Principle	156
3.3.2 Strengths and Weaknesses	158
4. ROTATING COOLERS	160
4.1 The Rotary Cooler or Tube Cooler.....	160
4.1.1 Principle	160
4.1.2 Design Features	160
4.1.3 Cooling performance	162
4.1.4 Strengths / Weaknesses	162
4.2 The Planetary Cooler.....	163

4.2.1 Principle	163
4.2.2 Historical	164
4.2.3 Design features.....	165
4.2.4 Internal heat transfer equipment (see Fig. 26)	165
5. VERTICAL COOLERS.....	167
5.1 The Gravity Cooler (G - Cooler)	167
5.2 The Shaft Cooler.....	167

SUMMARY

Clinker coolers have two tasks to fulfil:

- ◆ Recuperate as much heat as possible from the hot clinker by heating up the air used for combustion
- ◆ Cool the clinker from 1400°C to temperatures adequate for the subsequent process equipment, normally to 100 - 200°C.

There are mainly two different types of clinker coolers in operation with the following features:

Grate coolers

- ◆ Crossflow heat exchange through horizontal clinker bed with cold air from below.
- ◆ Cooling airflow exceeding combustion air requirement allows low clinker temperatures, but necessitates excess (waste) air dedusting.
- ◆ Modern cooler technology with sophisticated plates and forced aeration systems allow combustion air temperatures exceeding 1000°C.
- ◆ Trend to wider and fewer grates, less cooling air and fixed inlets
- ◆ Largest units: 10'000 t/d
- ◆ Travelling grate (Recupol): last unit built around 1980

Rotating coolers

- ◆ Rotary tube coolers with separate drive or planetary cooler attached to kiln shell
- ◆ Quasi counter-current flow heat exchange
- ◆ Cooling air determined by combustion air, no waste air
- ◆ Heat exchange (recuperation) determined by condition of internal heat transfer equipment
- ◆ Limited unit size, up to 3000 t/d
- ◆ Planetary cooler not suitable for precalciner technology
- ◆ Practically no new installation built anymore

1. INTRODUCTION

The clinker cooler is a vital part of the kiln system and has a decisive influence on the performance of the plant. Three key indicators characterize a good cooler:

- ◆ Maximum heat recuperation
- ◆ Minimum cooling air flow
- ◆ Unrestricted availability

There have been periodic changes in trends during the past decades. Grate coolers were first introduced by Fuller Company (USA) around 1930. While its design was continuously being optimized, the grate cooler became the predominant type in the 1950's. In the late 1960's, the planetary cooler gained popularity which reached its peak in the 1970's, mainly due to its simplicity. Larger unit capacities with precalciner technology made the grate cooler the preferred solution again. A wave of grate cooler reengineering starting in the mid 1980's has generated a much improved grate cooler technology as well as a new situation on the suppliers' side. New problems were experienced and have been or are being solved.

Since cement plants have life cycles of 40 years and more, numerous units of each cooler type, planetary, rotary or grate cooler of old or new designs, will remain in operation for many more years.

2. GENERAL CONSIDERATIONS

The clinker cooler has the following tasks to fulfil:

- ◆ Process internal heat recuperation by heat transfer from clinker to combustion air
- ◆ Reduce clinker temperature to facilitate clinker handling and storage
- ◆ Provide maximum cooling velocity to avoid unfavorable clinker phases and crystal size

2.1 Heat Flow in a Kiln System

The importance of the cooler as a heat recuperator can be well demonstrated with a heat flow (Sanki) diagram.

Figure 1 Clinker cooler and kiln system

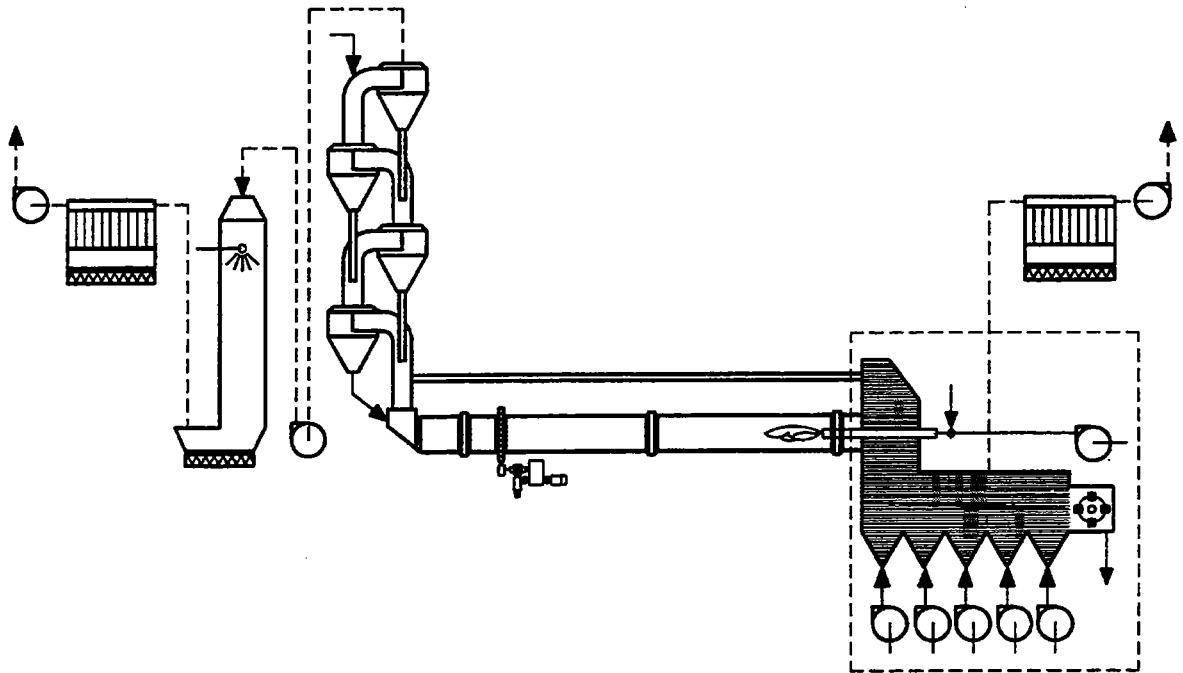
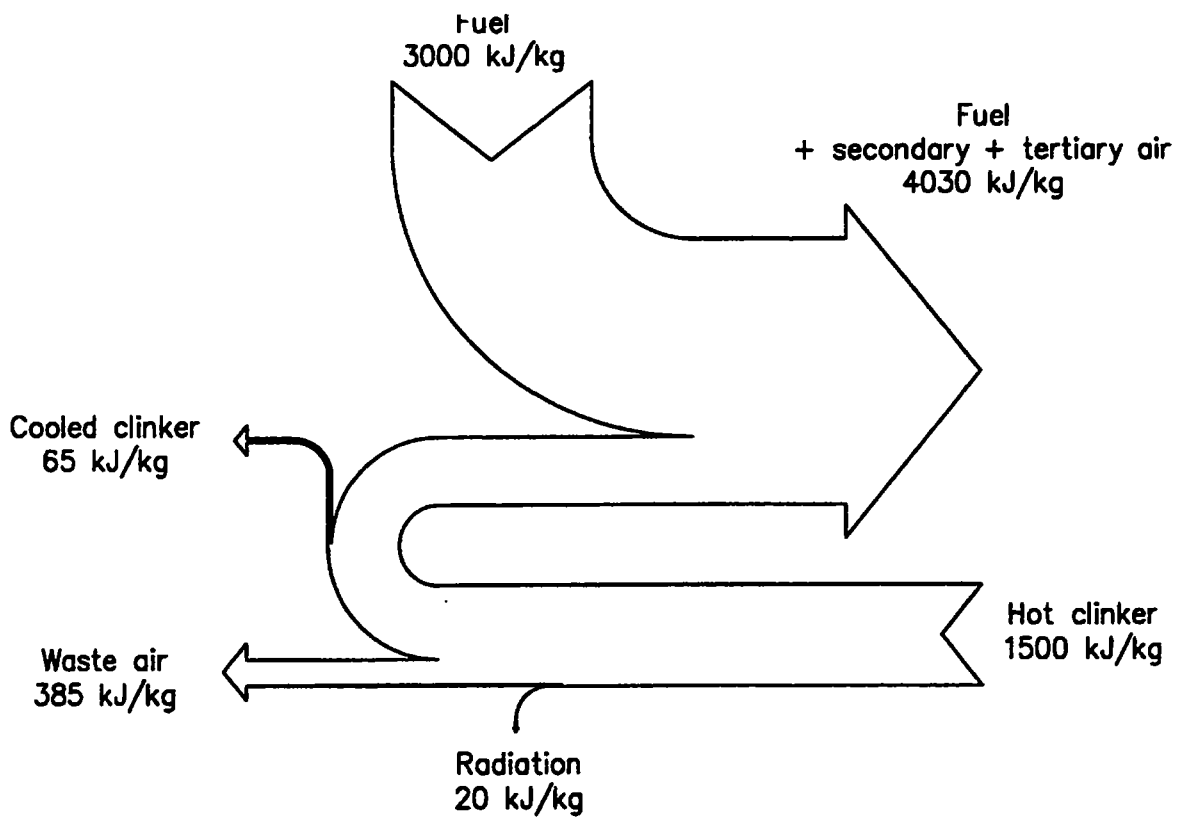

Figure 2 Energy turnover (Grate cooler)



2.2 Definitions

- ◆ As for other components of the kiln system, specific figures for clinker coolers refer to **1 kg of clinker**. This eliminates the influence of plant size and allows direct comparison of clinker coolers of different types and sizes.
- ◆ **Cooling air** is the air which passes the clinker thus being heated up while cooling the clinker. It corresponds approximately to the combustion air requirement, only grate coolers allow additional air for better cooling.
- ◆ **Primary air** is the air which is required for proper functioning of the burner. Ambient air insufflated by a separate small fan plus the air from a pneumatic transport system, amounting from < 10% up to > 30% of the air required to combust that fuel. Some precalciner burners are equipped with primary air fans (for cooling) as well.
- ◆ **Secondary air** is the hot air entering the rotary kiln via clinker cooler. Its flow is determined by the combustion of the burning zone fuel. While cooling the clinker, it reaches temperatures of 600 to over 1000°C, depending on type and condition of the cooler.
- ◆ **Tertiary air** is that part of the combustion air which is required for combusting the precalciner fuel. It is extracted from kiln hood or cooler roof, and then taken along a duct (=tertiary air duct) parallel to the kiln to the precalciner. It reaches temperatures near or equal to the level of the secondary air.
- ◆ **Middle air** (grate cooler only) is extracted from the cooler roof if drying of process materials requires a temperature level which is higher than the waste air. If the quantity is small, up to 450°C can be expected at normal cooler operation.
- ◆ **Waste air** (grate cooler only) is also called cooler exit air or cooler excess air. The total cooling airflow from the fans is normally higher than the flow required for combustion (=tertiary + secondary air). The extra air, which has normally a temperature of 200 to 300°C, must be vented to ambient via a dedusting system.
- ◆ **False air** is cold air entering the system via kiln outlet seal, burner opening, casing or clinker discharge. It either dilutes secondary air thus reducing recuperated heat or adds load to the waste air system of grate coolers.
- ◆ **Specific air volumes** are airflows per kg of clinker ($\text{m}^3/\text{kg cli}$, $\text{Nm}^3/\text{kg cli}$). Independent of the kiln size, airflows of cooler systems can be directly compared.
- ◆ **Specific loads** express the relation of clinker production to a characteristic dimension of the cooler (t/d m , t/d m^2 , t/d m^3). Exact definitions vary with cooler type.
- ◆ **Radiation losses** from the cooler casing/shell are particularly important for planetary coolers, where they actively support the cooling of the clinker.
- ◆ **Efficiency** expresses the quality of heat transfer from clinker to the air which is used for combustion in the burning zone and precalciner firing.

Remark: Since the heat recuperated is proportional to hot air used for combustion and temperature, an **efficiency** figure is **only meaningful** if it is related to a **heat consumption** figure (resp. a combustion airflow).

Figure 3 Clinker coolers - Definitions

Grate Cooler

- Active grate area : A (m^2)
- Grate length : L (m)
- Grate width : W (m)
- Grate inclination : Θ ($^\circ$)
- Number of grates : n_G (-)
- Installed fan power : P_F (kW)
- Installed drive power : P_D (kW)

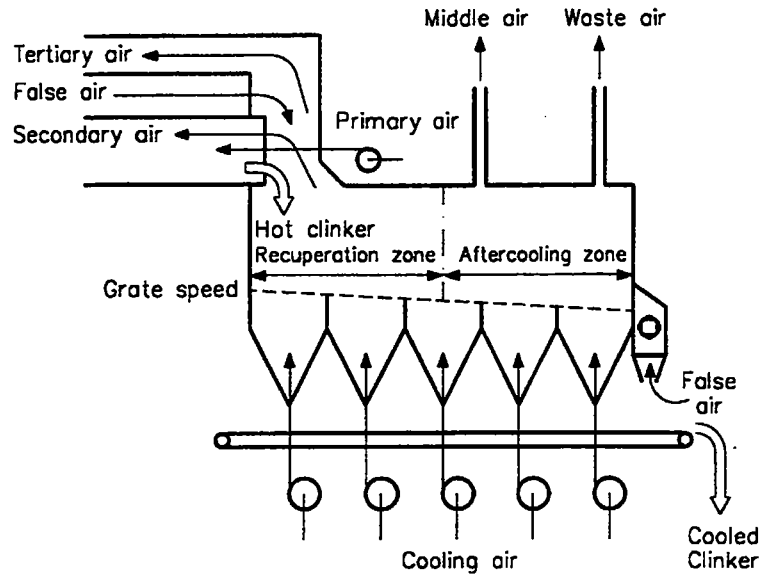

Planetary Cooler

- Tube length : L (m)
- Tube diameter : D (m)
- Elbow cross section : A_{elbow} (m^2)
- Number of tubes : n_t (-)
- Cylindrical surface : A_t (m^2)

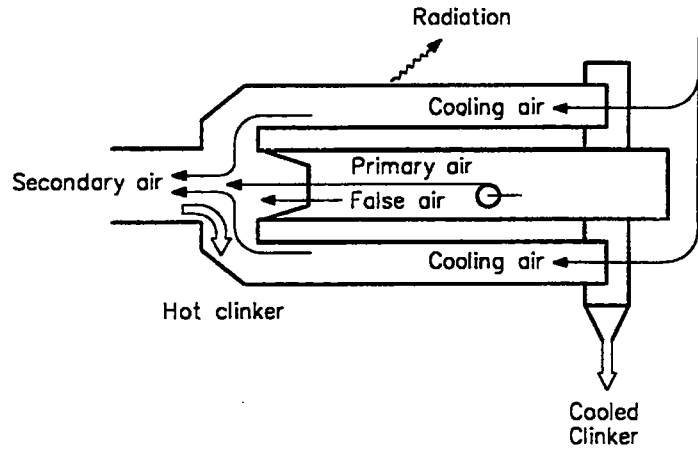

Tube Cooler

- Tube length : L (m)
- Tube diameter : D (m)
- Slope : Θ ($^\circ$)
- Installed drive power : P_D (kW)

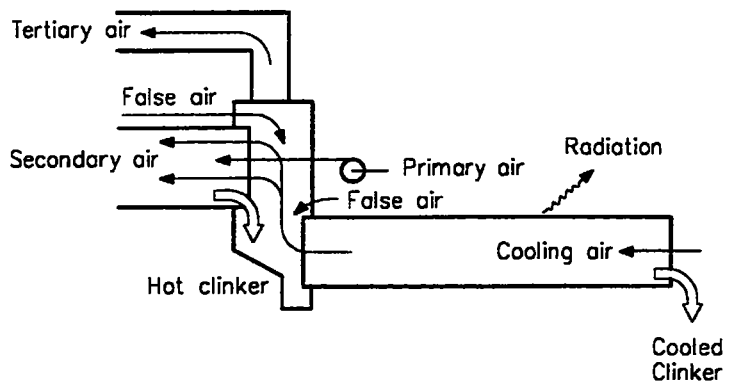

2.3 Calculations

The calculations below are examples of heat balance investigations:

• Heat in hot clinker Q_{cli} :	
$Q_{cli} = m_{cli} \cdot c_{p_{cli}} \cdot (t_{cli} - t_{ref})$	<p>Example with $m_{cli} = 1 \text{ kg/h}$:</p> <p>$t_{cli} = 1400^\circ\text{C}$:</p> <p>$Q_{cli} = 1 \text{ kg/h} \cdot 1.090 \text{ kJ/kg}^\circ\text{C} \cdot (1400^\circ\text{C} - 20^\circ\text{C}) = 1504 \text{ kJ/h}$</p>
• Heat in hot air Q_{air} :	
$Q_{air} = V_{air} \cdot c_{p_{air}} \cdot (t_{air} - t_{ref})$	<p>Example with $V_{air} = 1 \text{ Nm}^3/\text{h}$:</p> <p>$t_{air} = 1066^\circ\text{C}$:</p> <p>$Q_{air} = 1 \text{ Nm}^3/\text{h} \cdot 1.421 \text{ kJ/Nm}^3^\circ\text{C} \cdot (1066^\circ\text{C} - 20^\circ\text{C}) = 1486 \text{ kJ/h}$</p>
• Radiation loss Q_{rad} :	
$Q_{rad} = C_R \cdot \varepsilon \cdot A \cdot \left\{ \left(\frac{t}{100} \right)^4 - \left(\frac{t_o}{100} \right)^4 \right\}$	<p>Grate cooler</p> <p>$Q_{rad} = 20 \text{ kJ/kg cli}$ (from experience)</p>
Cooler efficiency η_{cooler}	$\eta_{cooler} = \frac{Q_{\text{combustion air}}}{Q_{\text{clinker from kiln}}} = 1 - \frac{\sum Q_{\text{loss}}}{Q_{\text{clinker from kiln}}}$

The secondary (+ tertiary) air requirements are dictated by the amount of fuel fed to the burners. Per this definition, the efficiency of a cooler is getting better with increasing kiln heat consumption. It is thus obvious that a cooler efficiency figure is only meaningful if the corresponding heat consumption (or airflow) is indicated.

Example:

production	5000 t/d
heat consumption	3000 kJ/kg cli
secondary and tertiary air temperatures	1066°C
Primary air main burner	10%
PC fuel ratio	60%
False air and excess air neglected (not realistic!)	

$Q_{\text{comb air}}$:

$$V_{\text{Comb air}} = 3000 \text{ MJ/kg cli} \cdot 0.26 \text{ Nm}^3/\text{MJ} \cdot 5000/24 \cdot 10^3 \text{ kg/h} \cdot (1 - 0.4 \cdot 0.1) = 156'000 \text{ Nm}^3/\text{h}$$

$$t_{\text{comb air}} = 1066^\circ\text{C} \rightarrow q_{\text{combustion air}} = 1.421 \text{ kJ/Nm}^3 \cdot (1066 - 20)^\circ = 1486 \text{ kJ/Nm}^3$$

$$Q_{\text{comb air}} = V_{\text{comb air}} \cdot q_{\text{comb air}} = 1486 \cdot 156'000 \text{ kJ/h} = 231'816 \text{ GJ/h}$$

Q_{clinker} :

$$m_{\text{clinker}} = 5000 \text{ t/d} / 24 \text{ h/d} \cdot 10^3 \text{ kg/t} = 208'333 \text{ kg/h}$$

$$t_{\text{clinker from kiln}} = 1400^\circ\text{C} \rightarrow q_{\text{clinker from kiln}} = 1.09 \text{ kJ/kg}^\circ \cdot (1400 - 20)^\circ = 1504 \text{ kJ/kg}$$

$$Q_{\text{clinker}} = 208'333 \cdot 1504 \text{ kJ/kg} = 313'333 \text{ GJ/h}$$

$$\text{Efficiency } \eta = 231'816 / 313'333 \cdot 100\% = \underline{74.0\%}$$

Figure 4 Clinker cooler typical data (4-stage SP Kiln, 2'000 t/d)

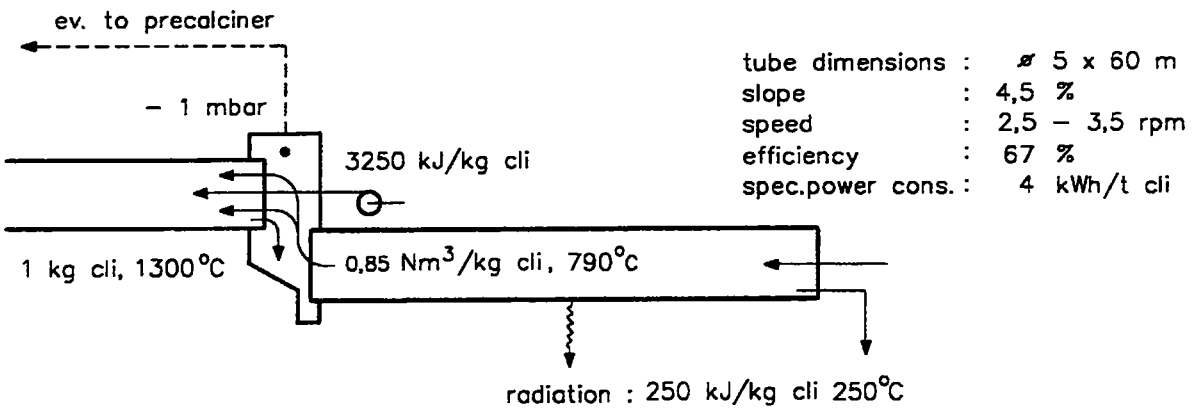
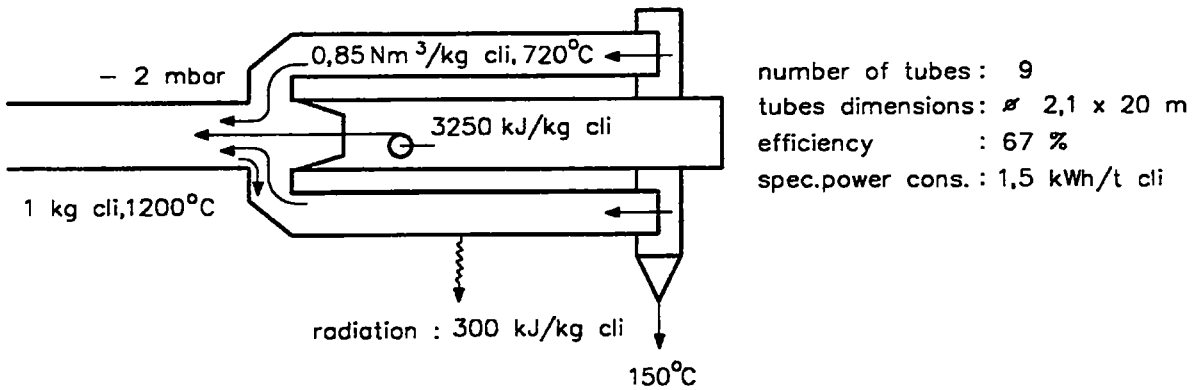
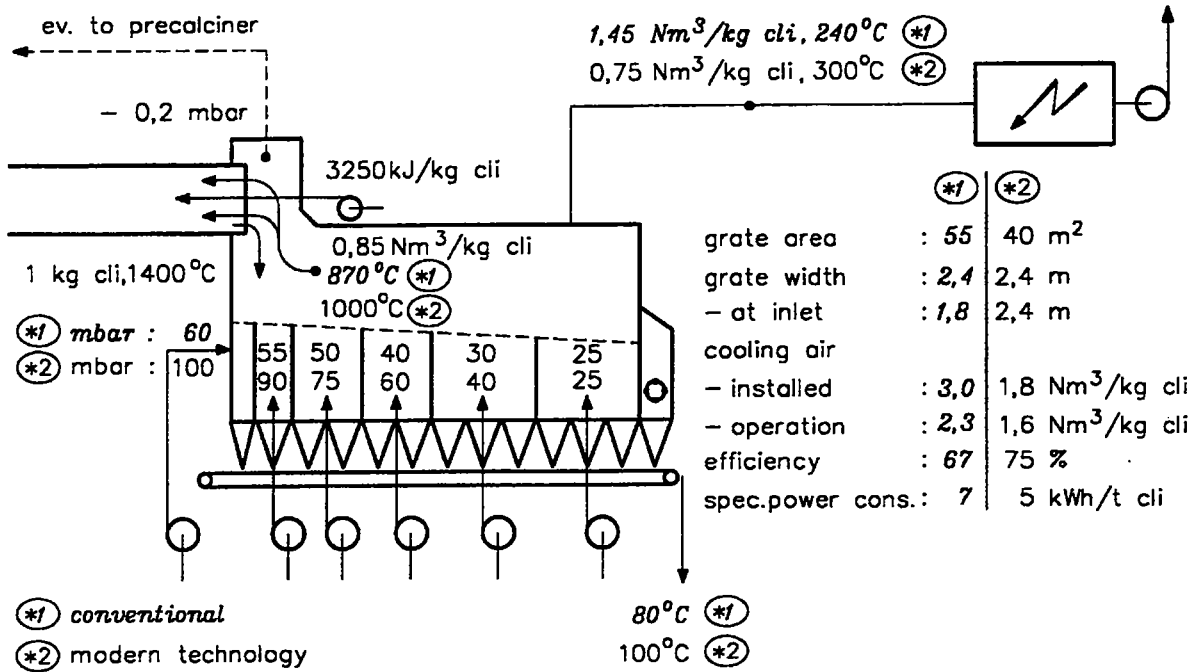

3. GRATE COOLERS

3.1 The Reciprocating Grate Cooler

The reciprocating grate cooler is the most widely applied type and is exclusively used for new plants.

3.1.1 Principle

- ◆ The following major **system components** can be distinguished:
 - Casing with kiln hood and connections for air at different temperature levels
 - Reciprocating grate with drive system
 - Aeration system with fans, undergrate compartments and direct air ducts
 - Riddling (= fall through) extraction system with hoppers, gates and transport
 - Clinker crusher
- ◆ **Material transport**
The clinker is pushed by the vertical part of the front edge of the preceding plate. The entire grate consists of a combination of fixed and moving rows which results in a quasi-continuous motion of the clinker bed.
- ◆ **Heat exchange**
Heat exchange from clinker to air is according to the **cross current** principle. The cooling air penetrates the clinker bed which is laying on the grate from underneath and leaves it at the surface. While passing through the hot clinker, the air is accumulating heat which is transferred from the clinker.
- ◆ **Cooling air**
Normally, ambient air is blown to underneath of the grate plates loaded with clinker by a number of cooling air fans. Delivery pressure must be sufficient to penetrate the clinker bed and to compensate for the expansion (increase of actual volume) of the air from heating it up
Under ideal conditions, the required cooling air depends directly from the desired clinker temperature. One part of the cooling air is used for combustion in the kiln, the rest is cleaned and vented to ambient, unless it is further used, e.g. for drying.
- ◆ **Cooling curve**
A simplified mathematical model for clinker cooling in a conventional, optimized grate cooler gives the relation between cooling air quantity and clinker temperature as follows:

$$\frac{T_{cli} - T_{amb}}{T_{cli in} - T_{amb}} = \exp[-(V_{air} / 0.77)]$$

- with
- | | | |
|--------------|---------------------------------------|-------------------------|
| $T_{cli in}$ | = clinker temperature at cooler inlet | °C |
| T_{amb} | = ambient temperature | °C |
| V_{air} | = cooling air quantity | Nm ³ /kg cli |

The above approximation (curve Fig. 17: $T_{cli} = 1400^{\circ}\text{C}$) has been found to give satisfactory results for conventional grate coolers from various suppliers.

Figure 5 Reciprocating Grate Cooler: Design Features

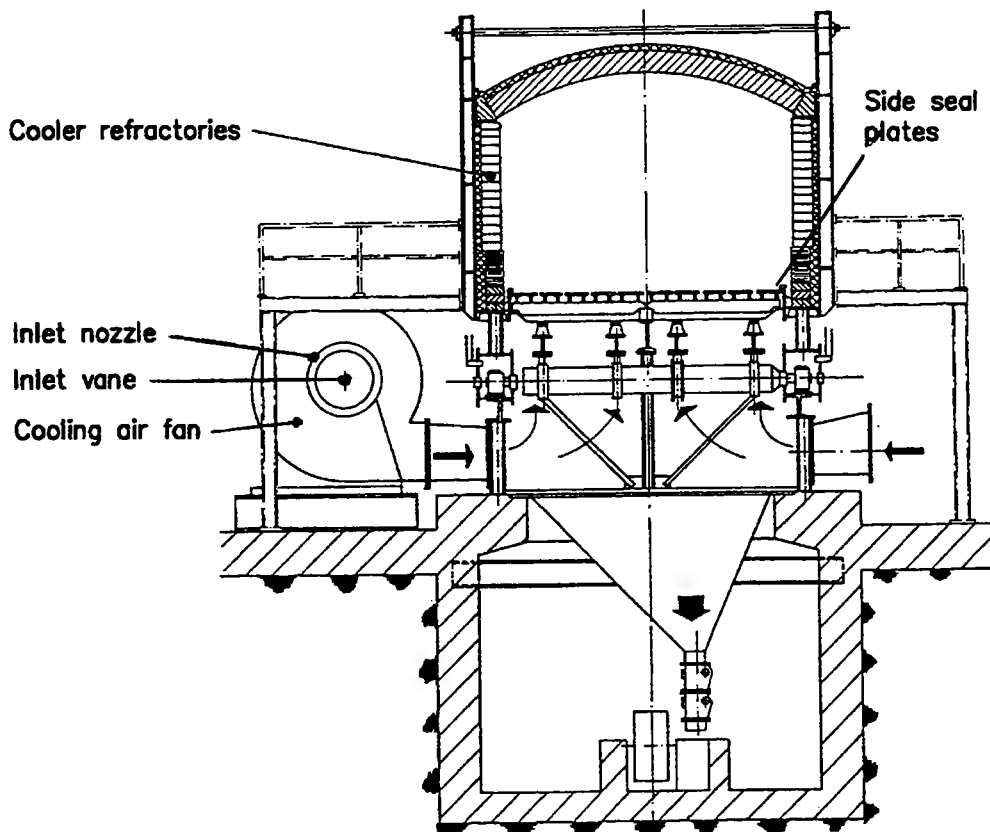
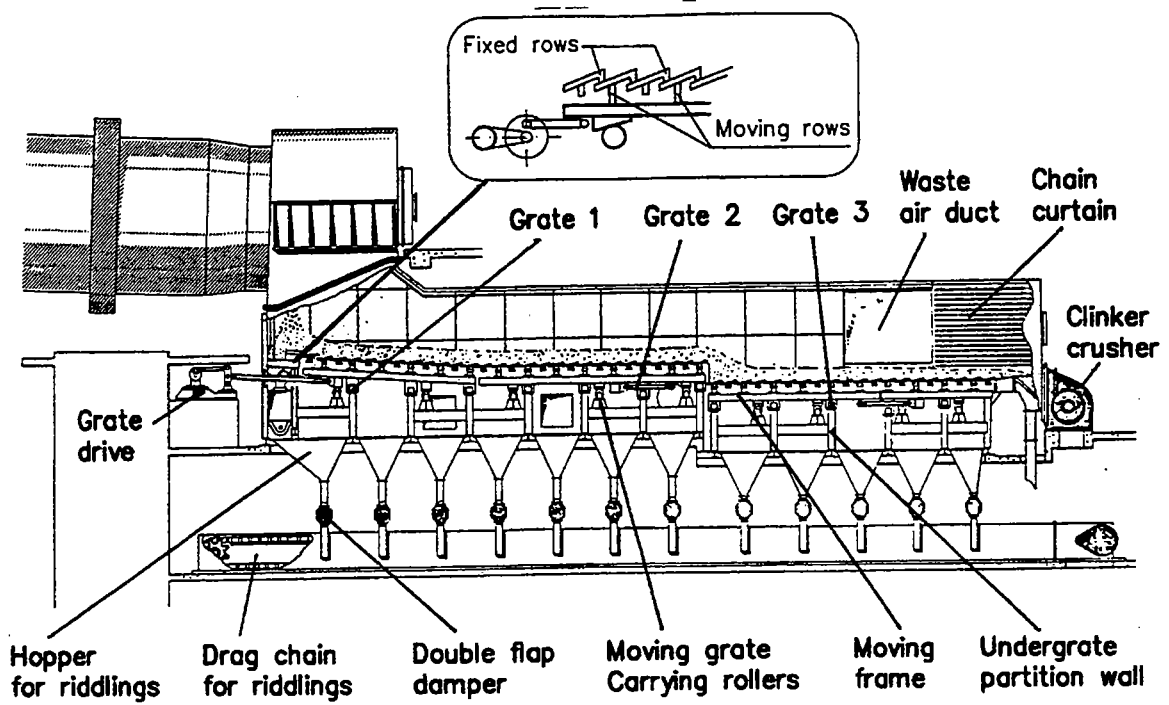

3.1.2 History

It was the Fuller Company (USA) who introduced the first reciprocating grate cooler in the late 1930's with a grate slope of 15°.

Fluidized material running down the grate leads to 10° grate inclination. The 10° cooler was predominantly used until the mid 1950's. Problems were encountered with those 10° coolers when the clinker was fine and started to fluidize. As an attempt to solve this problem, wedge grate plates were used. Another drawback of those 10° coolers was the building height required for larger units.

In the mid 1950's, the first horizontal grate coolers were introduced. They were initially just 10° grates installed horizontally with accordingly reduced conveying capacity. Some of these coolers were severely damaged by overheating, due to fluidization and accumulation of hot fine clinker at the feed end.

This drawback of the horizontal cooler led to the development of the so-called **combi cooler**. It has one (or formerly two) inclined grates with normally 3° slope, followed by one or two horizontal grates. Not all suppliers followed the same philosophies, so all three concepts (all horizontal, combi and all inclined) can be found all over the world.

The planetary cooler boom period in the 1970's came to an end, when large production capacities were in demand. Preheater technology required grate coolers which eventually needed to be reengineered again. Problems related to the clinker distribution, growing awareness of heat and power consumption as well as the demand for higher availability forced the suppliers to introduce new solutions. Initiated by the new company IKN, the grate cooler technology underwent significant changes since the mid 1980's. **Modern grate plates, forced (direct) aeration** and better **gap design** were introduced by all cooler makers helping to reduce cooling airflow and cooler size.

The new approach led to better recuperation in most cases. However, serious **wear problems** with the new systems forced most of the companies to modify their solutions once again. Today, in the mid 1990's, we are still gaining experience with latest designs.

The ultimate solution would be the **waste air free** grate cooler with unlimited flexibility and availability. However, right now the cement industry would be happy with smooth operation, high recuperation, low cooling air and no cooler related kiln stops.

Figure 6 Various configurations of reciprocating grate coolers

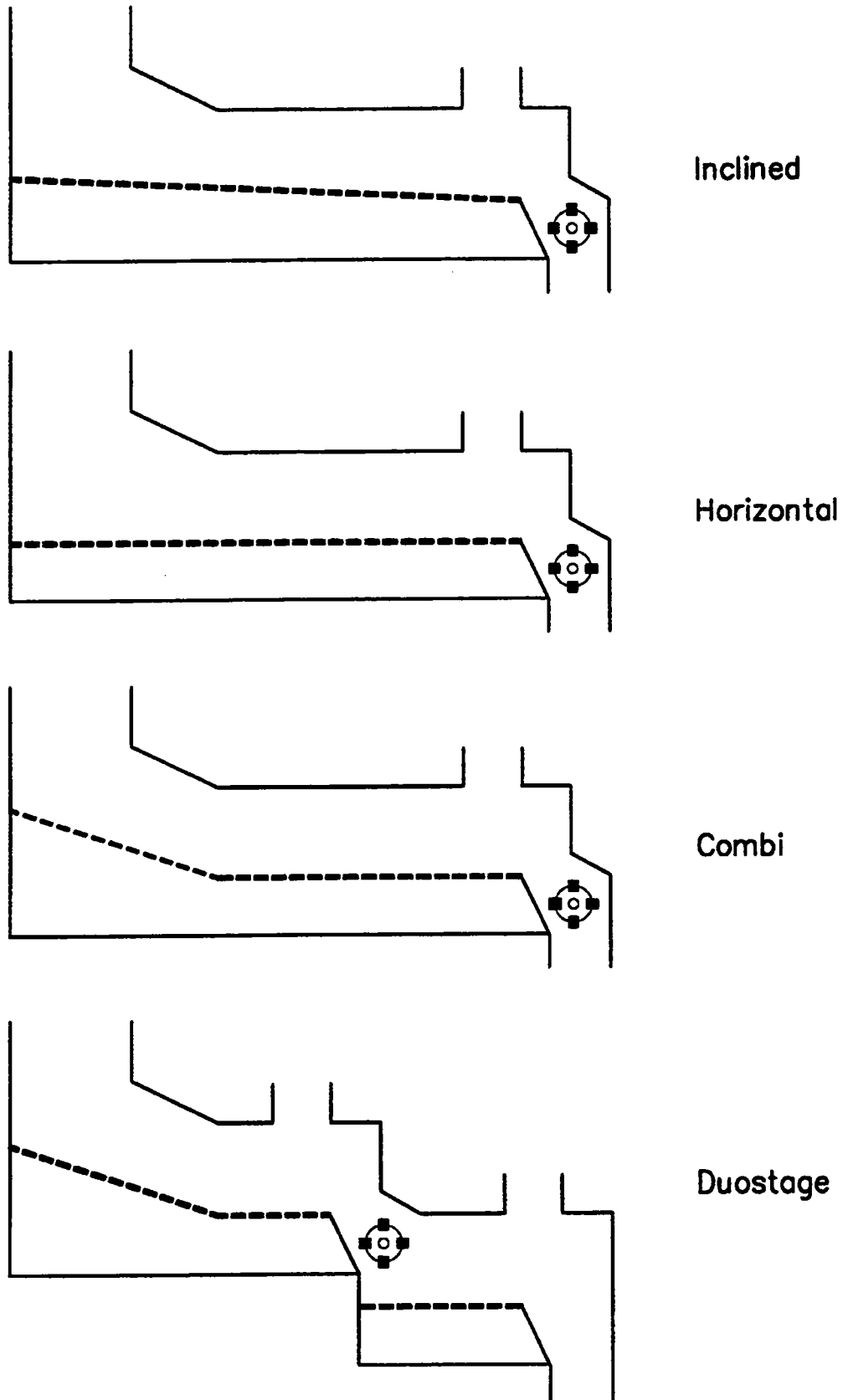

3.1.3 Conventional Grate Coolers (1980's)

3.1.3.1 Typical Design Features

- ◆ Grate plates with round holes
- ◆ Two to three grates, depending on size
- ◆ Grate slope 0° or 3° or both, depending on supplier
- ◆ Mechanical excenter drives for reciprocating grate
- ◆ Chamber aeration
- ◆ Fan pressure 45 mbar (first) to 25 mbar (last)
- ◆ Smaller compartments at inlet, larger towards outlet
- ◆ Clinker riddling extraction with hoppers, gates and dragchain (some earlier designs: internal drag chain without hoppers)
- ◆ Hammer crusher at cooler discharge

World's largest kilns (10'000 t/d in Thailand) are equipped with conventional grate coolers from CPAG with 4 grates.

3.1.3.2 Strengths and Weaknesses of Conventional Grate Coolers

Strengths	Weaknesses
<ul style="list-style-type: none"> • Lower clinker end temperature due to higher amount of cooling air • Possibility of adjusting cooling air and grate speed provides higher flexibility • Optimization possibilities during operation 	<ul style="list-style-type: none"> • Waste air handling system (dedusting, fan) required • More complex cooler requires higher capital investment • Higher power consumption than planetary or tube cooler • Uneven clinker discharge / segregation leads to several problems • Red river • Snowmen • Air breakthrough (bubbling, geyser) • Reduced plate life • Excessive clinker fall through between gaps

Causes and mechanism of those problems are further explained in the next paragraph.

Figure 7 Conventional grate coolers: Design features

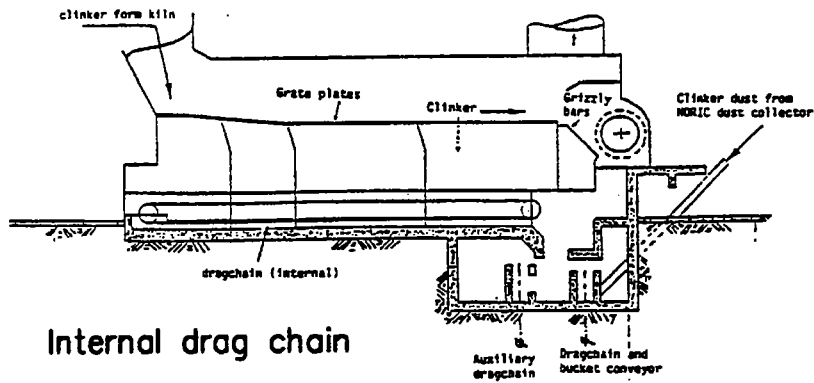

Internal drag chain

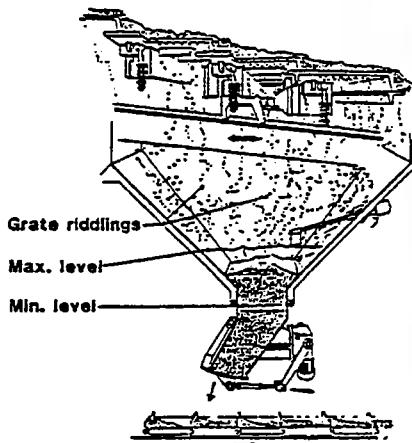

Knife gate (CPAG)

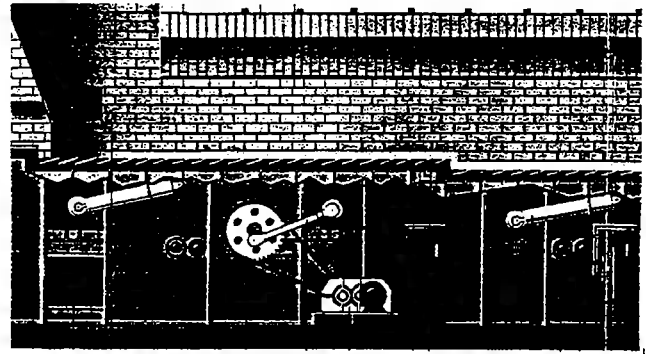

Grate drive with shock absorbers to center the grate (KHD)

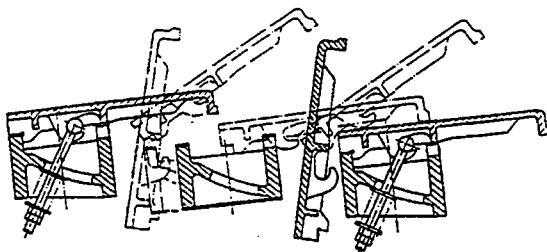

Plate installation (Polysius)

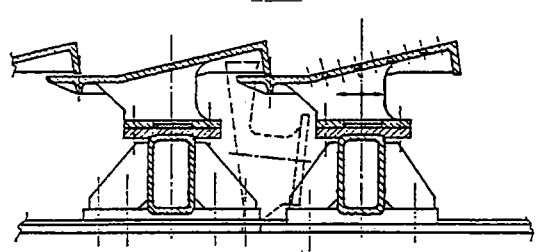

Plate installation (FLS)

3.1.4 Typical Grate Cooler Problems

Most grate coolers show a tendency to one or more of the system inherent problems, and in many cases there is no real cure. Investigations of the causes lead to the development of the modern cooler technology.

◆ **Segregation:**

Due to its physical properties, the clinker is lifted by the kiln rotation before it is discharged into the cooler. Installation of the grate axis offset from the cooler axis should compensate for this effect. However, since discharge behavior of finer and coarser clinker particles differ from each other, the clinker fractions are not evenly distributed across the grate. Fines are discharged later and are thus found predominantly on the rising side of the kiln shell (Fig. 8a).

◆ **Thin clinker bed in recuperation zone:**

With a conventional grate cooler with chamber aeration, the clinker bed thickness is limited directly by the installed cooling fan pressure and indirectly by the quality of compartment seals and distribution of the clinker across the width. In order to avoid overheated plates, the operator will set the bed not higher than allowed to guarantee airflow through the plate carrying the clinker with the highest bed resistance. Thin bed operation leads to unfavorably high air to clinker ratio and poor heat exchange on the sides with consequently low recuperation efficiency.

◆ **Red river:**

The infamous red river is one of the most feared problems with grate coolers. Due to segregation, fine clinker has always its preferred side (see above). Different bed resistance on either side and only one air chamber across the entire width often cause fluidization of the fine clinker laying on top. This fluidized clinker does no longer follow the speed of the grate, but shoots much faster towards the cooler discharge end. Because the residence time of that fine clinker is much reduced, it does not follow the general cooling curve and forms a red hot layer on top of the regularly cooled, already black clinker. Hence the term "red river". It is not the missed heat recuperation, but the red hot material being in touch with cooler walls, plates and side seals in the colder area where such temperatures should normally not occur. Premature destruction of those pieces results in poor availability, high maintenance and ultimately in loss of production and sales revenues.

◆ **Snowman:**

The sticky consistence of the hot clinker leaving the kiln combined with the compaction at the drop point often leads to formation of solid clinker mountains on the grate. Not permeable for cooling air, they grow larger and disturb the flow pattern of the clinker in this anyway critical inlet area.

◆ **Air breaking through:**

Due to the different resistance of the clinker bed and the fear of overheated plates, too much air is put on the first grate compared to the clinker bed. The result is air shooting through the bed, hardly taking any heat and thus not contributing to the heat exchange. In addition to that, the clinker is mixed which can be seen by the bubbling action, and the layered clinker bed (colder clinker below, hotter on top) is destroyed thus disturbing the cross flow heat exchange pattern.

The results are low recuperation and too much heat going to the aftercooling zone.

Figure 8a: Segregation at cooler inlet

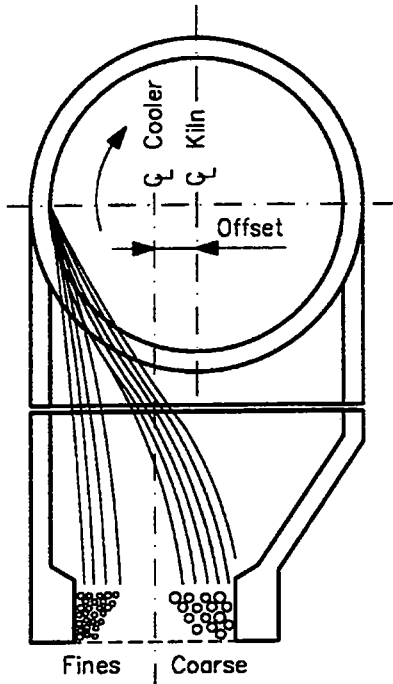

Figure 8b: Clinker bed depth effect on cooling

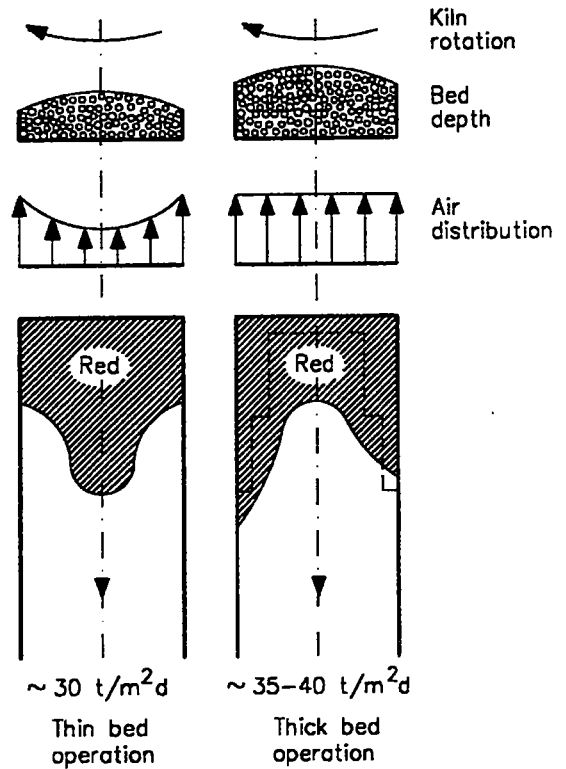

Figure 8c Red River

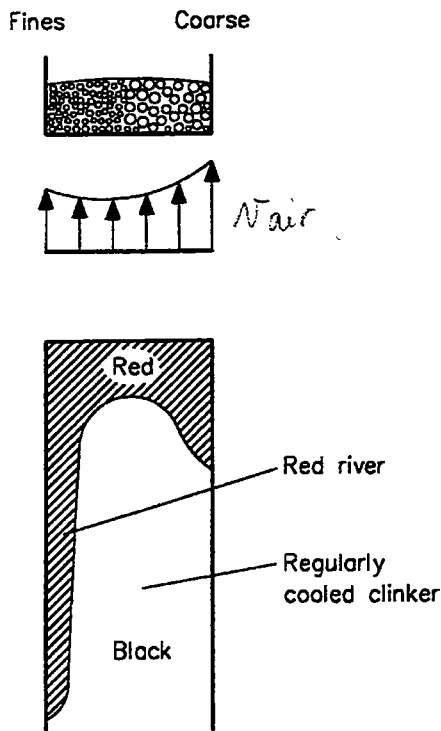
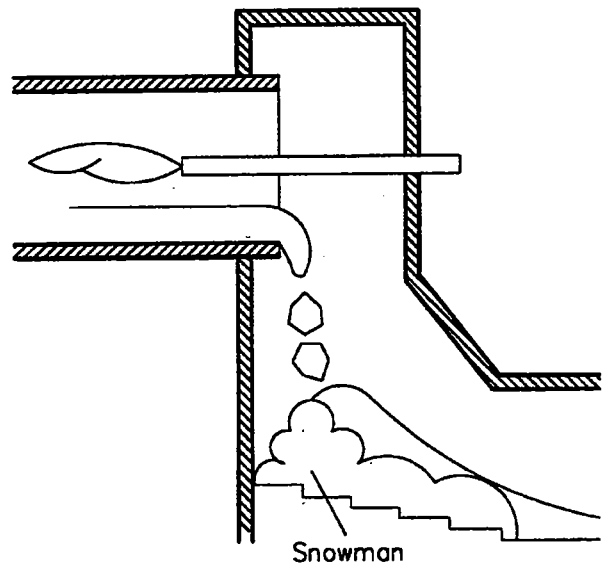

Figure 8d Snowman



3.1.5 Modern Grate Coolers (1990's)**3.1.5.1 Design Features**

The successful clinker cooler has:

- ① Correct allocation of cooling air to clinker
- ② Sustainable gap widths in the entire cooler

All new or redesigned clinker coolers are aiming at the above two goals:

- ◆ Modern grate plates, designed to cope with high temperature differences
- ◆ Inclined inlet section without moving rows
- ◆ Pattern of zones for individually adjustable aeration in recuperation zone
- ◆ Modern plates for a tight grate in the after cooling zone
- ◆ New, improved side seal plate design for tight gaps and low wear
- ◆ Careful undergrate compartment sealing
- ◆ Adequate seal air system with correct control
- ◆ Wider and shorter coolers; lower number of grates
- ◆ Improved and wear protected moving grate support and guidance
- ◆ Hydraulic grate drive with optimized control system
- ◆ Cooling air fans with inlet vane control and inlet nozzle for measuring flow
- ◆ Roller crusher

3.1.5.2 Strengths and Weaknesses of Modern Grate Coolers

Strengths	Weaknesses
<ul style="list-style-type: none"> • More constant heat recuperation → improved, smoother kiln operation • Cooler inlet: improved clinker distribution across grate width • Elimination / control of red river • Significantly reduced grate riddlings (clinker fall through) • Higher waste air temperature (valuable for drying) • Lower heat consumption due to higher heat recuperation (cooler efficiency) • Reduced power consumption due to less waste air • Lower civil cost due to more compact cooler • Lower investment due to smaller waste air system • Reduced cost for maintenance 	<ul style="list-style-type: none"> • More complicated mechanical installation (varies with supplier) • Higher secondary air temp. increases wear of nose ring and burner refractories • Higher actual (m³/h) tertiary air flow can increase dust entertainment at take off point • Teething problems with new designs - > design changes still in progress

Figure 9 Modern Grate Coolers: Design features

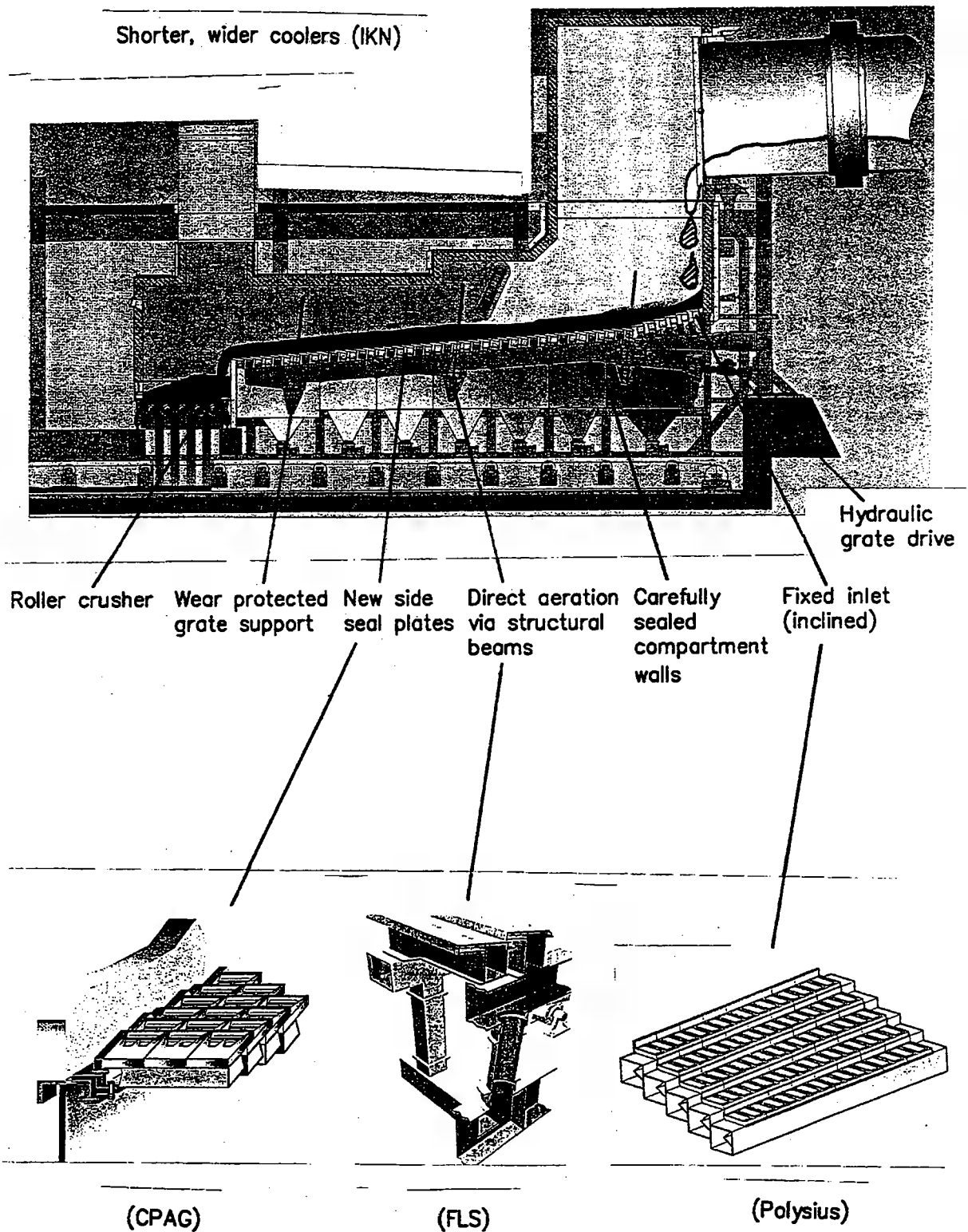

3.1.6 Design Highlights of Modern Grate Coolers

3.1.6.1 *Modern Grate Plates*

In the mid 1980's, the first modern grate plates were installed in grate coolers by IKN and CPAG. They were designed for the following targets:

- ◆ Allow for lower air/clinker ratio in the recuperation zone for higher recuperation
- ◆ Improve clinker distribution across the grate width
- ◆ Assure that all grate plates are always sufficiently cooled by air

The above targets were reached using the following ideas:

- **Higher built-in pressure drop**
Similar to the effect of thick bed operation, a higher pressure drop across the plate reduces the relative influence of variations in permeability of the clinker bed.
- **No more fine clinker falling through**
Fine clinker falling through means loss of heat and thermal stress on the drag chain. For forced aeration (below) it is mandatory that no material can fall in the air ducts where it would cut off the air supply.
- **Forced (direct) aeration via air ducts**
In order to ensure that all plates get enough air, to allow individual allocation of air to different areas and to avoid that air escapes through gaps, groups of plates are supplied with air directly via a special duct system
- **Tight gaps between plates and plates/casing**
Not only through the grate surface, but also through gaps between plates within the same row as well as from one row to the next, fine clinker can fall through. Those gaps have to be sealed as well, e.g. by interlinked steps in the plate sides (Fuller, Polysius) or by bolting them together as packages (IKN).

The modern grate plates are the basis of modern cooler technology. Problems experienced with the first generation of modern grate plates lead to several detail modifications:

- ◆ Cracks in corners of air outlet openings
→ Solution: modified shape
- ◆ Plastic deformation caused premature failure with many designs
→ Solution: thermally flexible plates built from two or more pieces
- ◆ Preferred plate internal airflow left plates locally uncooled
→ Solution: plate internal guide vanes, optimized air channelling

Modern grate cooler, as the IKN Pendulum Cooler, use also Pneumatic Hopper Drains (PHD) to withdraw the fine clinker fall through.

Figure 10 Modern grate plates

Fig.10a Conventional hole plate

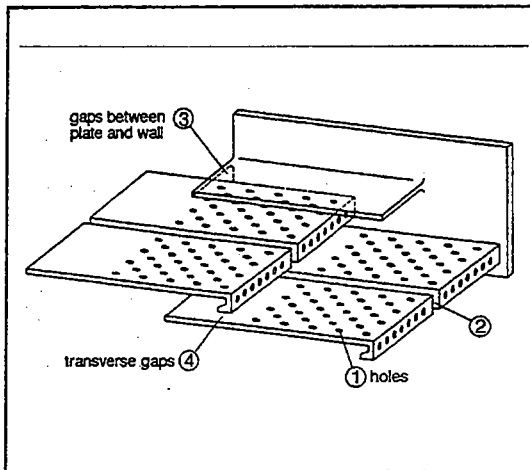

Fig.10b Coanda plate (IKN)

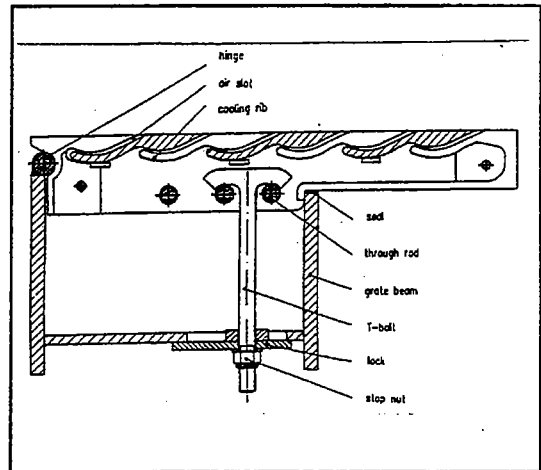

Fig.10c Mulden plate (CPAG)

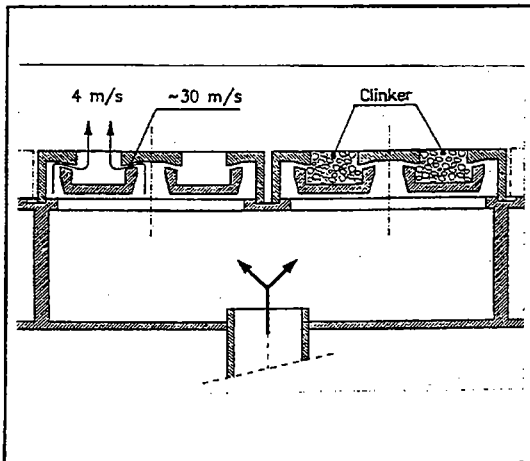

Fig.10d Controlled flow grate (Fuller)
 CFG plate

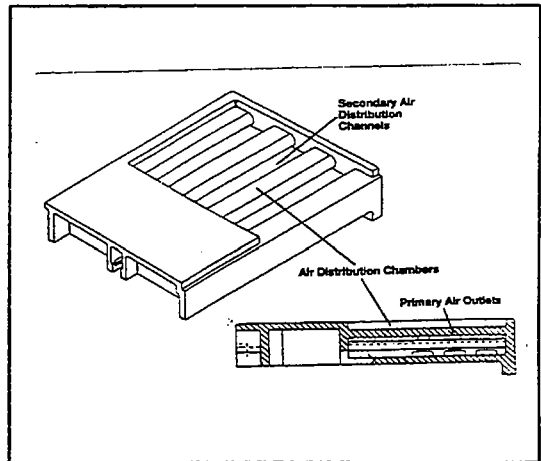

Fig.10e Jet ring plate (Polysius)

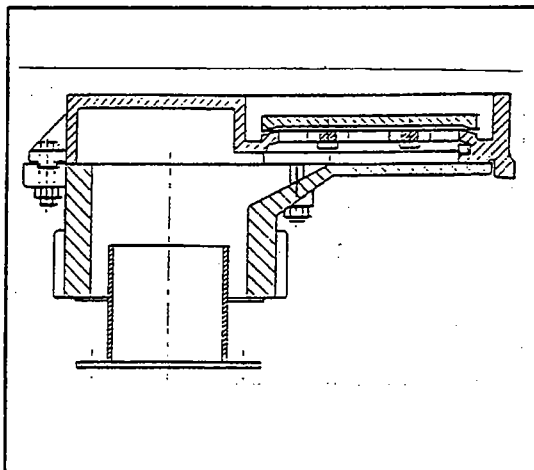
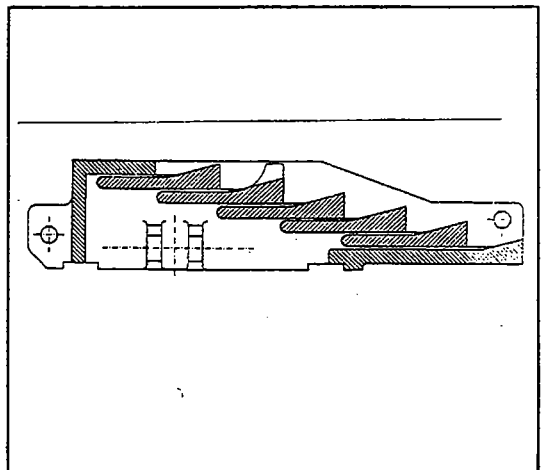

Fig.10f Step plate (KHD)



3.1.6.2 Air Ducts

The concept of forced aeration, i.e. the idea to bring the air directly to the grate plates requires a flexible air connection between the (stationary) fan and the moving rows.

Initially, the most obvious and simple approach was chosen: flexible hoses or bellows. IKN, CPAG, Polysius and Fuller used this solution at the beginning.

However, experience showed that those hoses were sensitive to design (geometry), installation and material qualities. While many coolers operated without any problem, others showed frequent rupture of those hoses, very often causing severe plate damage and consequently kiln downtime.

Meanwhile, all suppliers developed new solutions. Only KHD avoided these problems by using telescopic ducts from the beginning.

The individual suppliers are now using the following standard solutions:

- ◆ Telescopic air connector (BMH-CPAG, KHD)
- ◆ Ball and socket type air connector (FLS, Fuller)
- ◆ Gate type air connector (Polysius)
- ◆ Open air beam (IKN)

Figure 11 Forced (direct) aeration to moving rows: Flexible ducts

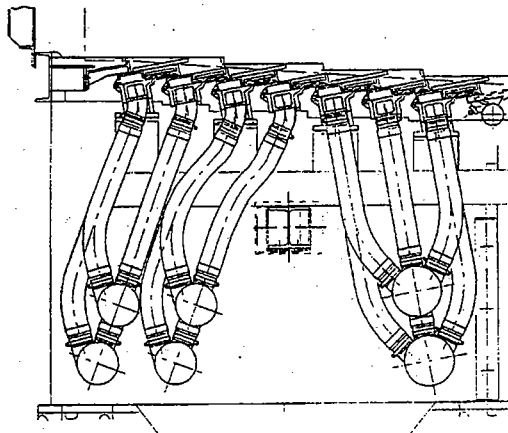

Polysius (old)

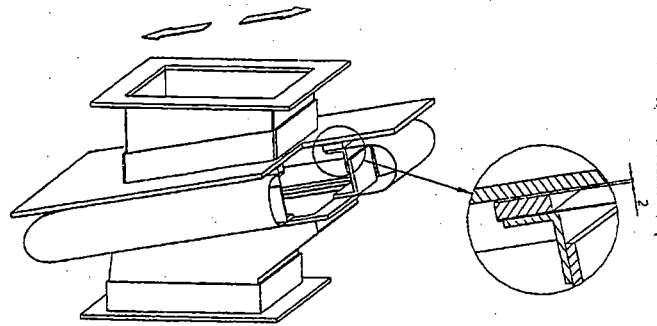

Polysius (new)

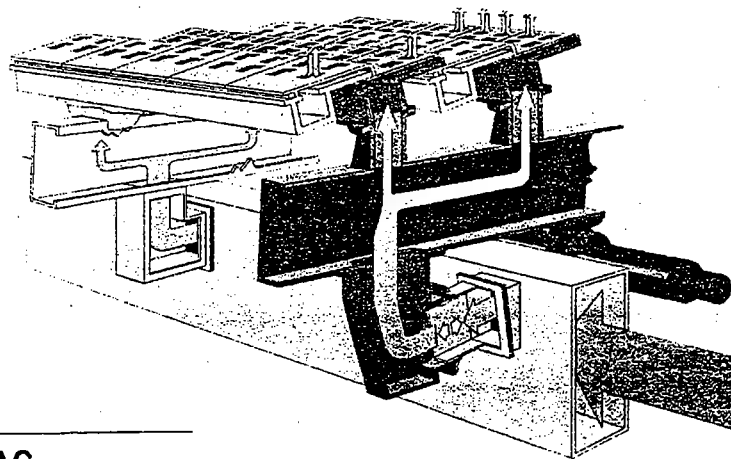

CPAG

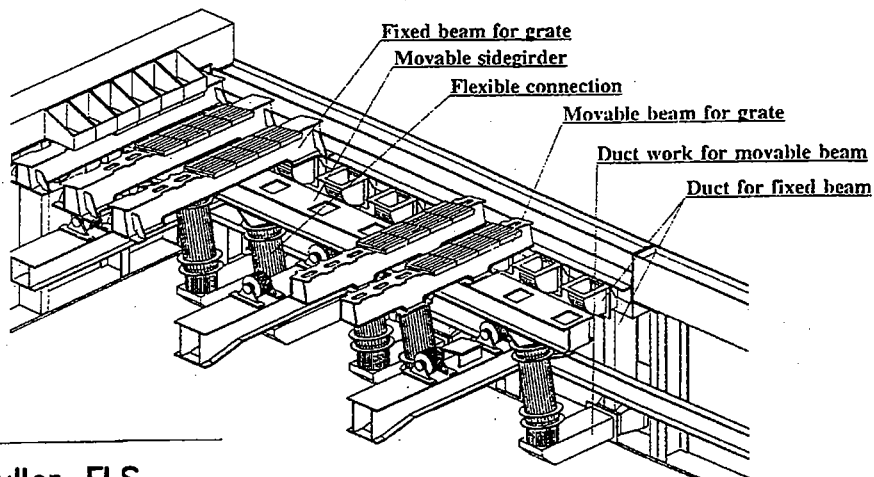

Fuller-FLS

3.1.6.3 Aeration Concept

It was soon recognized that only a few (6 to 8) rows of direct and individual aeration are not sufficient to improve clinker distribution or to eliminate/control red river formation. The number of rows with direct aeration was gradually increased and soon the suppliers started to equip the entire recuperation zone or even the entire cooler with direct aeration. Indeed, this improved the control possibilities, but created the following new drawbacks:

- ◆ Complicated and expensive equipment
- ◆ More parameters to control
- ◆ Difficult access underneath grate
- ◆ High number of potential problem areas (flexible hoses!)

Ways had to be found to reduce the number of air ducts to the individually aerated cooler zones. There are two ways to achieve this:

- ◆ Reduce number of individually aerated zones
- ◆ Modify the air duct system

Today, the following different solutions with varying degrees of experience are presently available from the suppliers:

- ◆ No moving rows requiring flexible air connectors in inlet section
- ◆ Longitudinal structural beams designed as air ducts
- ◆ Short air ducts from one moving row to the next (“Air bridge“)
- ◆ Direct aeration for fixed rows only (“hybrid aeration“)
- ◆ Full chamber aeration with modern grate plates

Figure 12 Aeration patterns

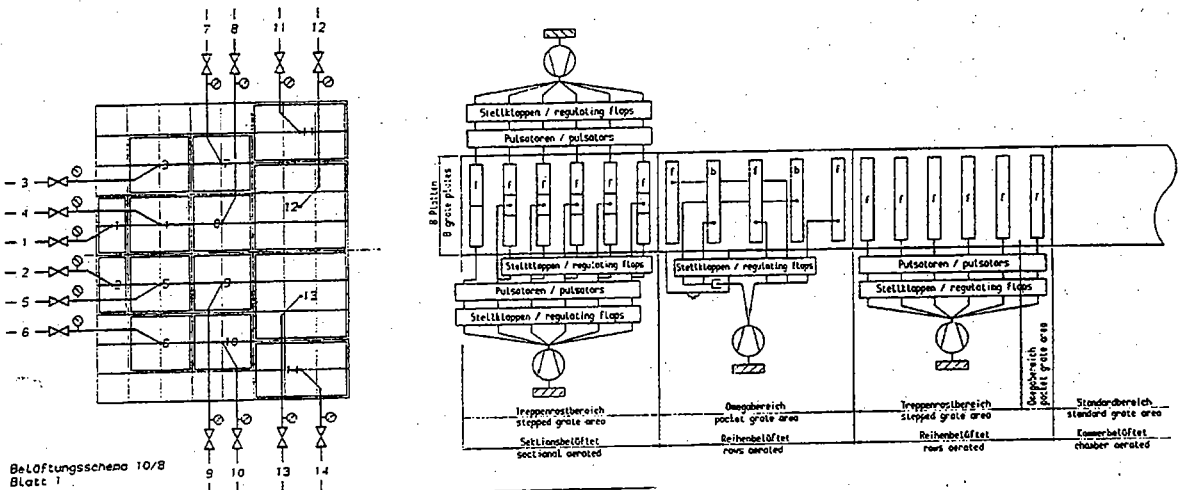

Polysius

KHD

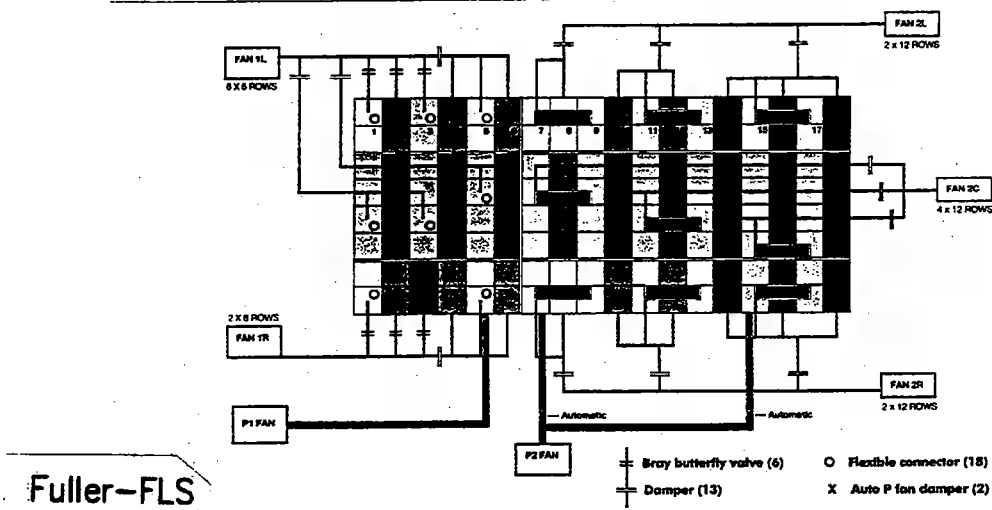
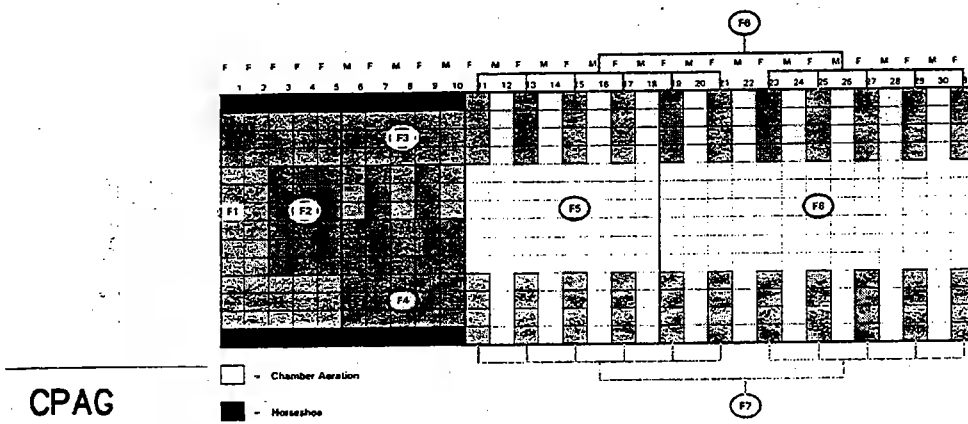

3.1.6.4 Seal Air (Confining Air)

When direct plate aeration was introduced, the significance of the seal air or confining air was not properly investigated. It was expected that direct individual aeration of the plates alone would be enough to get the desired improvement due to better air to clinker allocation.

If the cooler grates were tight and had no or very narrow gaps between moving and fixed rows or between grate and cooler casing, this would indeed be true. However, real grates have large gaps, which is one of the reasons why direct aeration was introduced.

The effect of insufficient seal air pressure for direct aerated grates can be explained as follows:

- ◆ High resistance in clinker bed (bed thickness, kiln upset, granulometry)
- ◆ Cooling air sneaks around plate edge to undergrate compartment instead
- ◆ Clinker dust carried in this air → abrasion / wear
- ◆ Gap becomes larger → seal air can escape → more "sneak" air
- ◆ Stops for repair reduce availability and increase operating cost

Today it is generally accepted that partition, sealing and pressurizing of the undergrate compartments is even more important than with chamber aerated coolers.

Ideally, the partition of the undergrate compartments should repeat the pattern of the individually aerated grate zones of the grate itself. Since this would lead to very complicated and expensive designs with difficult access, simpler solutions had to be found.

One of the most common countermeasures is, to install larger seal air fans. It was interesting to observe the installed cooling air to be gradually increased with each new project. This did not only lead to larger waste air systems but also to higher cooling fan motor power which partially offset the savings expected from modern coolers.

The suppliers have proposed the following improvements:

- ◆ Larger seal air fans
- ◆ Seal air branched off from cooling air fans
- ◆ Seal air from booster fan using air from cooling air fans
- ◆ Undergrate pressure controlled by cooling air fan pressure
- ◆ Careful sealing of undergrate compartments
- ◆ No more moving rows in hot inlet zone

Figure 13 Seal air systems

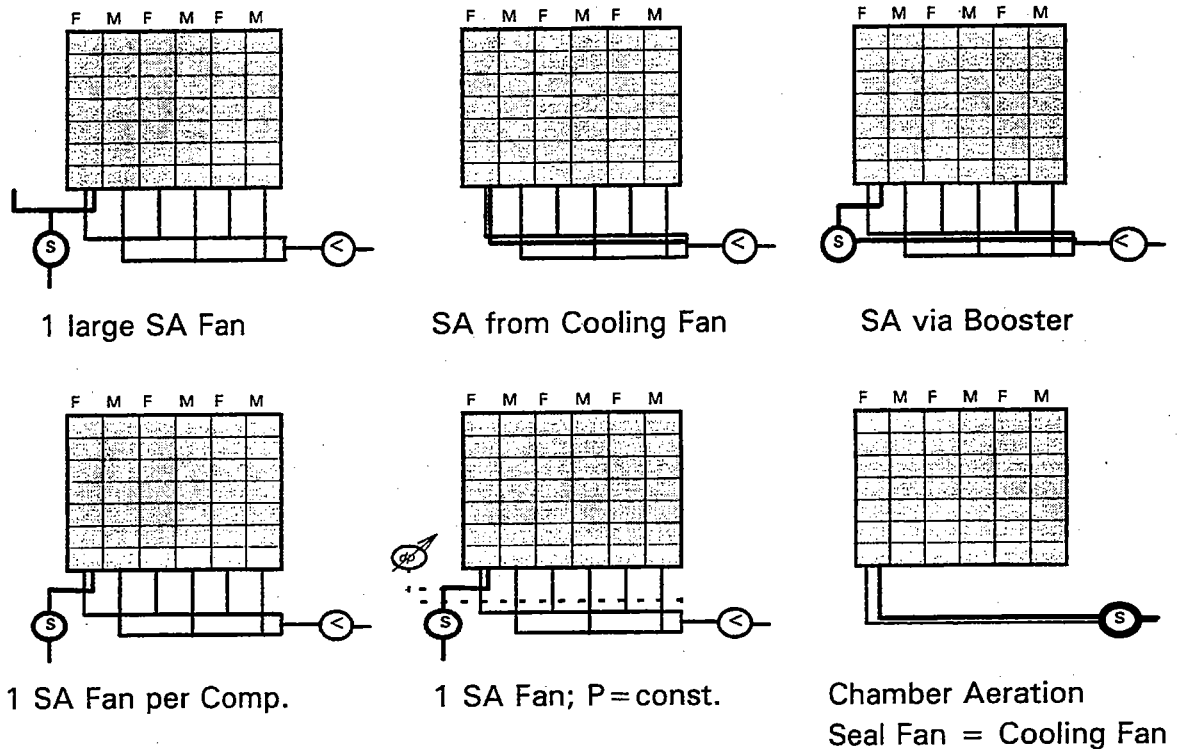

3.1.6.5 Side Seal Systems

Extremely serious wear problems occurred along the side seal plates on each side of the grate. Excessive fall through along the sides and shockingly short lifetime of the side seal plates, mainly in the recuperation zone, were the result. The main reasons for this problem can be listed as follows:

- ◆ The same seal element used for lateral and longitudinal movement
- ◆ Side seal plates fixed to cooler casing
- ◆ Entire thermal expansion to be compensated by (cold) gap on each side
- ◆ Side plates used for lateral guidance of the grate (older designs)
- ◆ More lateral thermal expansion of wider grates for large units

The following new solutions have been developed and are now part of the contemporary standards:

- ◆ Entirely new side seal plate concepts
- ◆ Side seal plates bolted to cross beams of fixed rows (no longer to cooler casing)
- ◆ Joints for thermal lateral expansion and mechanical longitudinal movement between moving rows and casing separated
- ◆ Center grate guide for large coolers

Figure 14 Side seal designs

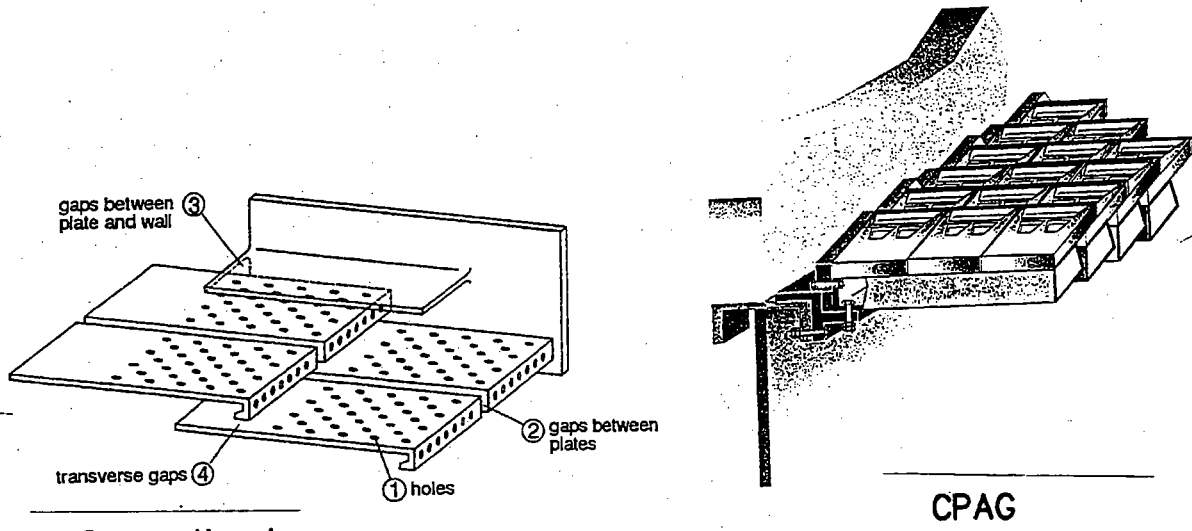

Conventional

CPAG

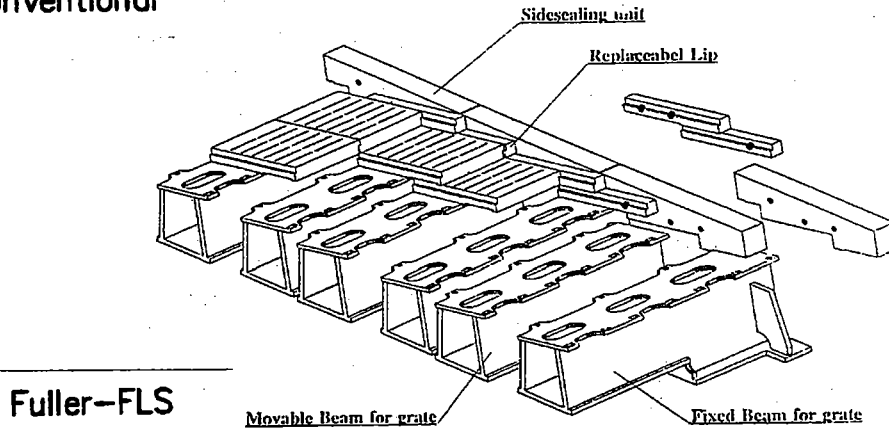

Fuller-FLS

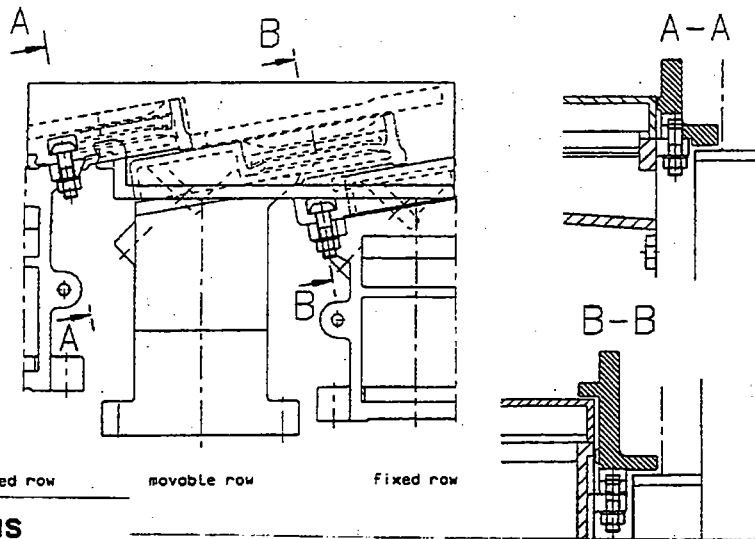

Polysius

3.1.7 Clinker Crushers

All kiln systems produce larger than normal clinker lumps more or less frequently. Large balls of material enter the cooler when coating drops during kiln upsets.

Such large clinker masses can only be cooled superficially and contain a lot of heat. Before being discharged to the clinker conveyor, they must at least be crushed to smaller particles.

All clinker coolers, regardless of the type, are equipped with a clinker crusher. Traditionally, this is a hammer crusher which has proven to be reliable.

In order to cool large clinker lumps, they must be crushed within the cooler. In reality, this means installing the crusher before the last grate. Early trials with hammer crushers were not successful, however.

Based on the idea and experience with roller grate bottoms in shaft kilns (and shaft coolers), CPAG developed the roller crusher to be used as intermediate crusher in a step cooler.

The advantages of the roller crusher make it also superior at the cooler outlet. Hydraulic or electric drives as well as different combinations of reversing rollers are available from various suppliers.

Compared to the hammer crusher, the roller crusher is rated as follows:

Strengths	Weaknesses
<ul style="list-style-type: none">• low speed• low wear• low dust generation• equalization of material rushes• suitable for high temperatures• lower power consumption	<ul style="list-style-type: none">• higher initial investment• chokes easier• more difficult to design

Figure 15a Hammer crusher

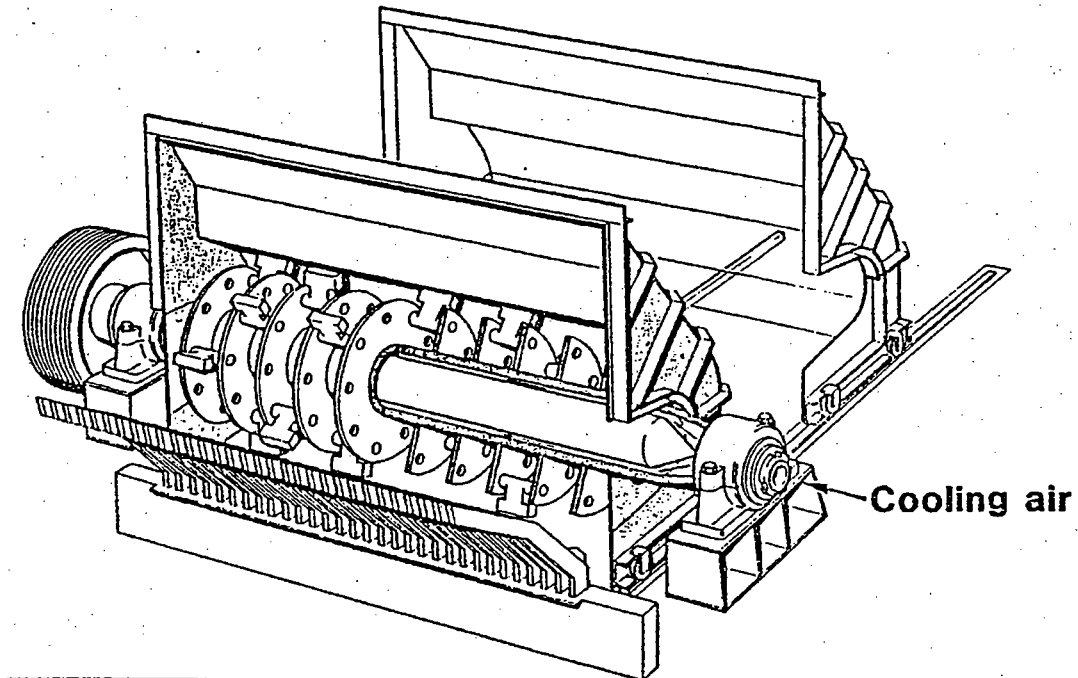
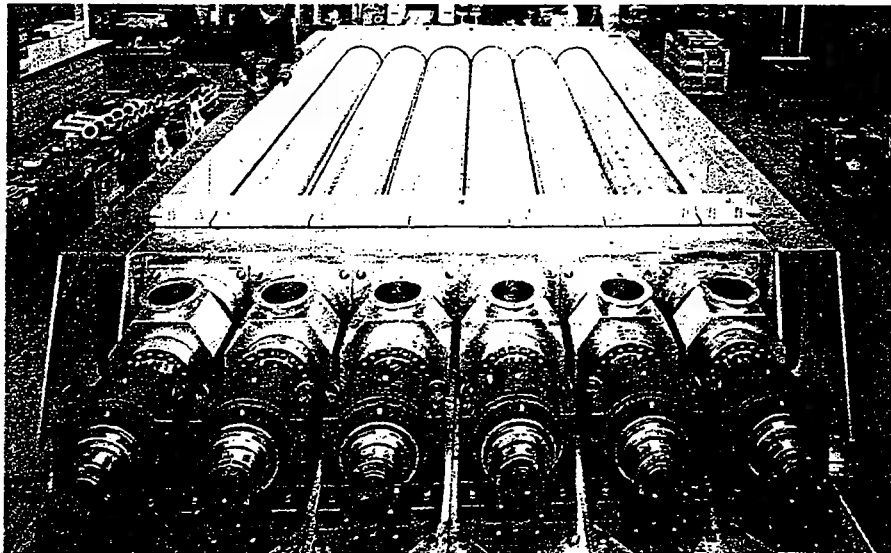
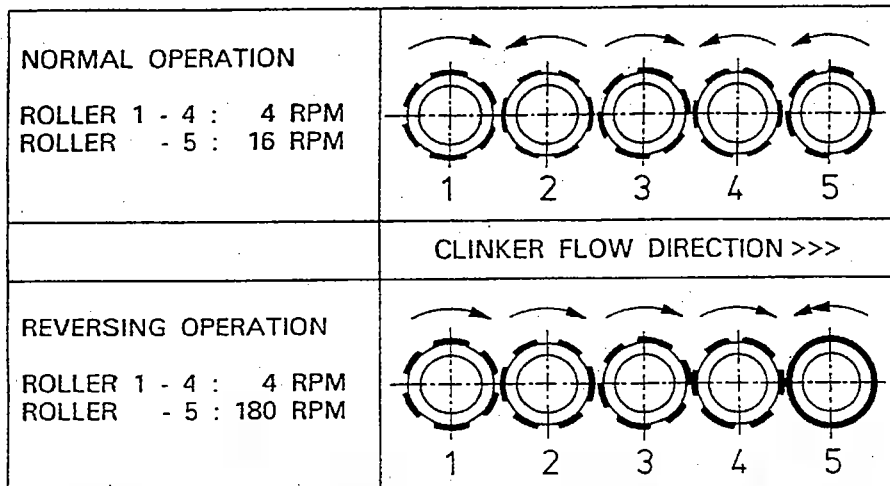
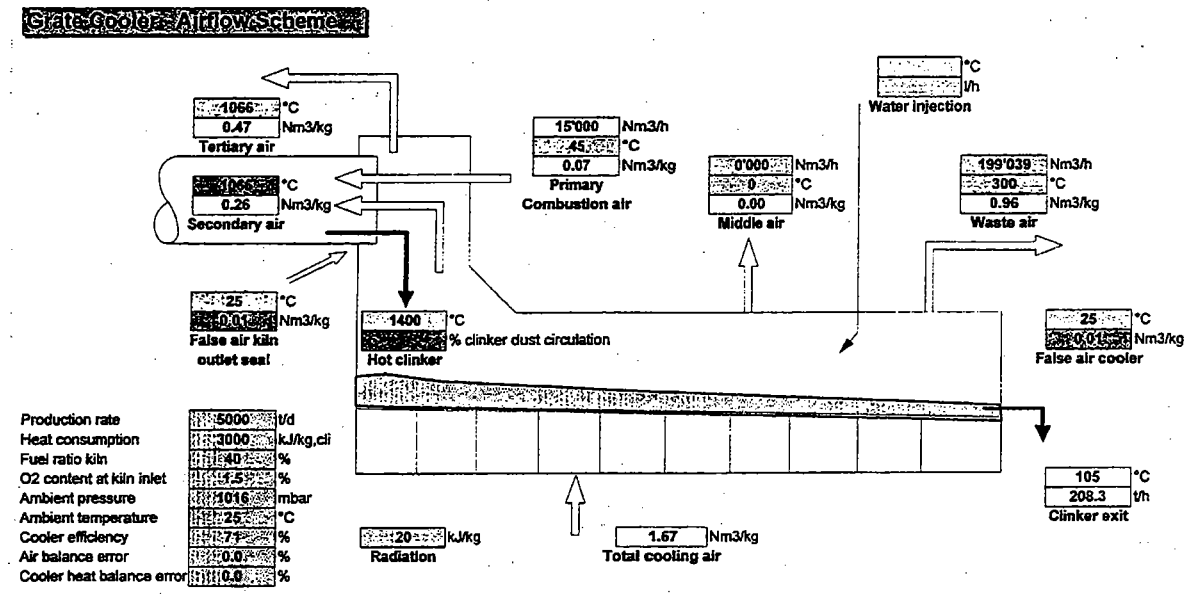

Figure 15b Roller crusher



CPAG

Figure 16 Heat and air balance of a modern Grate cooler



HEATBALANCE SUMMARY

<u>INPUT</u>		[°C]	[kJ/kg, cl]	
Clinker from kiln		1400	1504.2	99.3%
Cooling air	sensible heat	25	10.8	0.7%
False air	sensible heat	25	0.1	0.0%
Water injection	sensible heat			
Total of inputs			1515.0	100.0%
<u>OUTPUT</u>				
Clinker	sensible heat	105	66.9	4.4%
Secondary air (dust incl.)	sensible heat	1066	379.3	25.0%
Tertiary air	sensible heat	1066	695.4	45.9%
Middle air	sensible heat	0	0.0	0.0%
Waste air	sensible heat	300	353.7	23.3%
Radiation loss			20.0	1.3%
Water evaporation				
Rest	0.0 %		-0.2	0.0%
Total of outputs			1515.0	100.0%

Figure 17 Optimization

Cooling curve

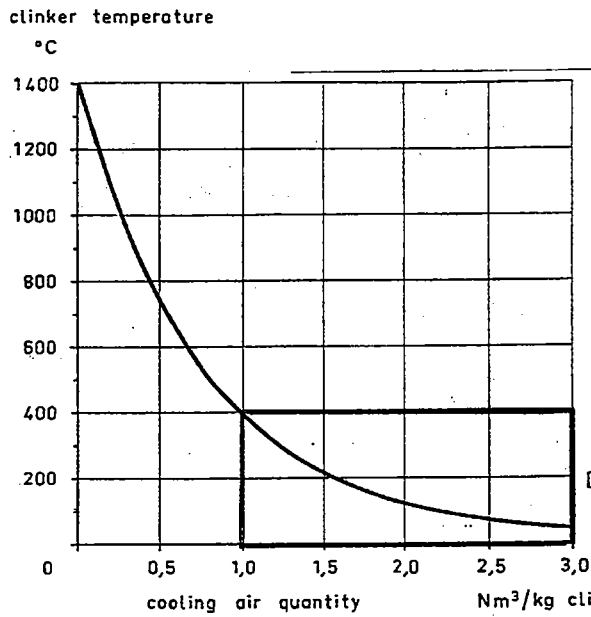

Clinker exit temperature

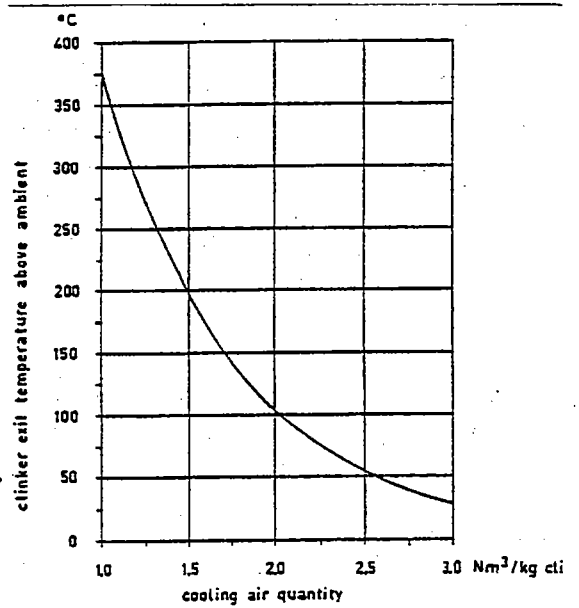

$$\frac{T_{cli\ exit} - T_{amb}}{T_{cli\ inlet} - T_{amb}} = \exp\left(-\frac{\text{cooling air (Nm}^3/\text{kg cli)}}{0.77}\right)$$

Clinker inlet temperature 1400 °C
 Ambient temperature 20 °C

Effect of cooler losses

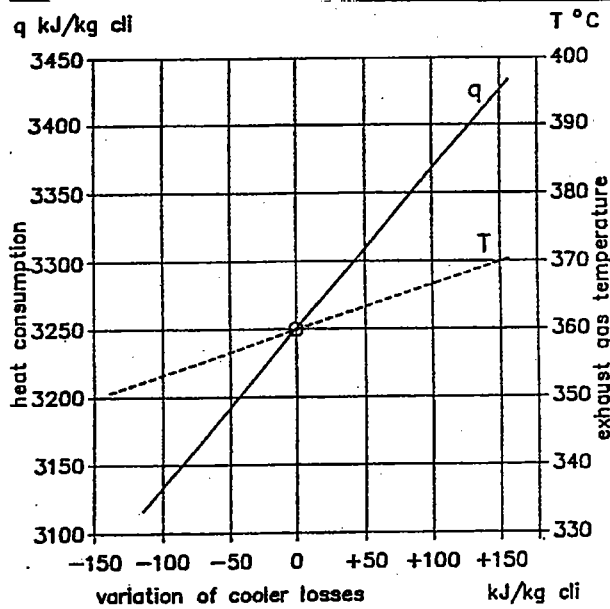

Grate cooler efficiency

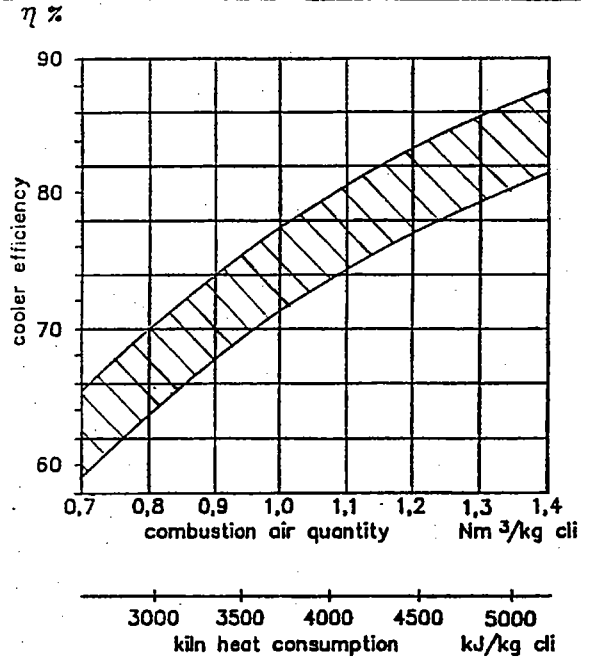

3.1.8 Cooler control

One of the advantages of the reciprocating grate cooler is its high flexibility, due to operating variables adjustable independently from kiln operation. Usually three main variables are controlled automatically.

a) Grate speed

In order to prevent the clinker bed resistance from exceeding the pressure capabilities of the cooling fans (which would mean too little cooling air and danger of heat damage), the bed resistance on the grate should be kept constant.

To do this, each grate section drive is controlled by the undergrate pressure of the first or second compartment in each grate section. An increase in pressure indicates an increase in bed resistance (either more material in the cooler or finer material). The reaction is an increase of the grate speed, causing the bed to become thinner. If the undergrate pressure decreases, the drive slows down and the bed becomes thicker.

Another possibility is to control only the first grate by the undergrate pressure, and to keep the speed of the following grates proportional to the speed of the first grate.

More sophisticated control systems use the weighted average of several undergrate pressures to control first grate speed. In many cases, however, control systems amplify fluctuations from the kiln instead of smoothening them. Increasing the bandwidth of the control system has shown good results in several cases.

b) Airflow

This control is complementary to the grate speed control. It maintains a constant volume of cooling air entering the cooler independently from the grate underpressure.

Each cooling fan is equipped with a piezometer sensor which will recognize an increase or decrease of the airflow and cause the cooling fan damper to close or open (in case of inlet vane damper control) or the fan motor speed to decrease or increase (in case of variable speed fan drives).

During normal conditions the cooling fans operate at about 2/3 to 3/4 of their maximum performance so that enough spare capacity is left to cope with eventual kiln rushes.

Together, grate speed and air flow control will on one hand ensure a sufficient cooling air supply to the cooler and, on the other hand, tend to provide more uniform combustion air temperature to the kiln.

c) Hood draft

The third component of the cooler control system is the hood draft control.

An automatically controlled grate cooler can improve the whole kiln operation and allows the operator to concentrate on other problems.

The kiln hood pressure is used to regulate the cooler vent air fan speed to maintain a constant pre-set draft. As the draft tends to become positive, the cooler vent fan speed is increased. This takes more air from the cooler and maintains the draft setpoint. As with the other controls, reaction in the opposite direction is just as important.

Coolers with radiation walls (IKN) allow hood draft control by one of the first cooling air fans.

Figure 18 Cooler control

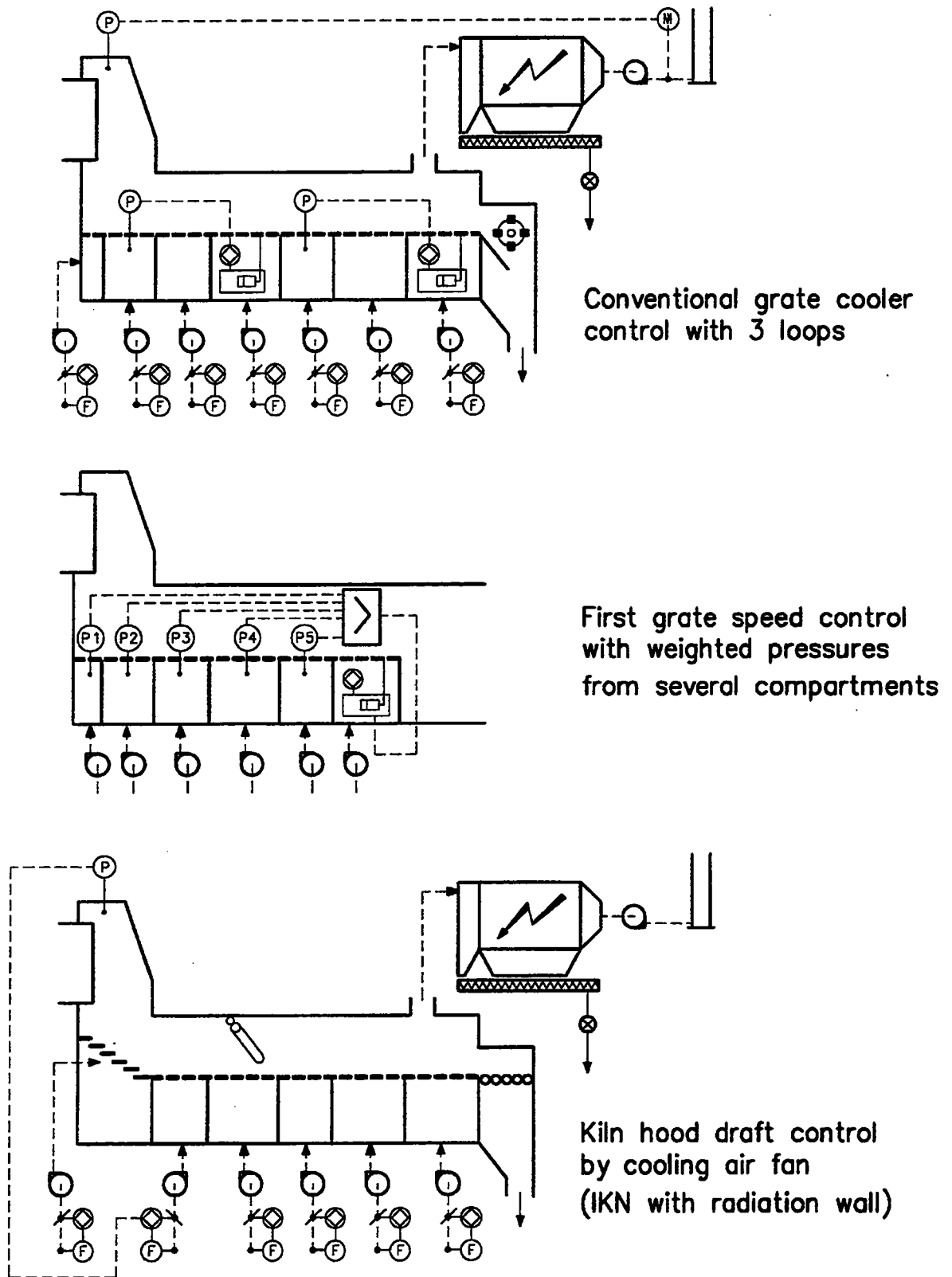

3.1.9 Cooler Dedusting

While dedusting of kiln exhaust gas can be commonly solved by using one type of dust collector only (electrostatic precipitator), the choice of the most adequate system for dedusting clinker cooler vent air raises quite often many discussions. This choice problem is basically a result of the special and fluctuating conditions of the vent air to be dedusted:

		normal operation	kiln upset
airflow (actual volume)	%	100	up to 150
air temperature	°C	200 - 250	up to 450
air dew point	°C	5 - 20	5 - 20
dust load	g/Nm ³	5 - 15	25 - 35

The dust particle size distribution can vary in a wide range depending on the burning conditions in the kiln.

Dimensioning of the dedusting equipment must take into account the worst conditions, in order to maintain the required clean gas dust content even at kiln upset condition.

The types of dust collectors for this application are compared below. Today's trend is:

- ◆ multiclones will no longer be tolerated in new and many existing plants
- ◆ gravel bed filters have proved to be inefficient and expensive
- ◆ use of electrostatic precipitators is possible without restriction
- ◆ bag filters with cooling of the vent air in a heat exchanger are often used nowadays

Type of collector	Strengths	Weaknesses
multiclone	simple low investment cost low space requirement not sensitive to temperature peaks	poor efficiency for particles < 20 µm efficiency sensitive to gas flow fluctuation comparatively high pressure loss high operating cost
electrostatic precipitator	low pressure loss low operating cost low maintenance cost	big unit required or use of pulse generator -> high investment cost possibly water injection required
gravel bed filter	not sensitive to temperature peaks	highest investment cost highest pressure loss high operating cost
bag filter	high efficiency relatively low investment cost	no bags for temperatures up to 450°C → precooling required high pressure loss high operating cost high maintenance cost

Figure 19 Grate cooler dedusting

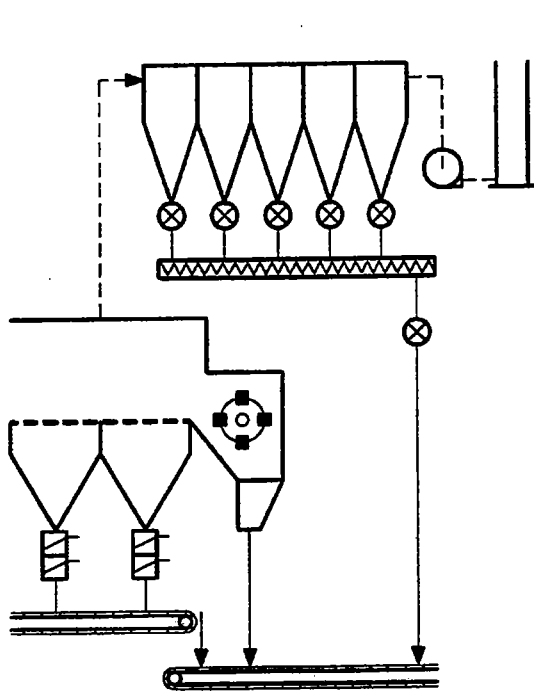

Multiclone

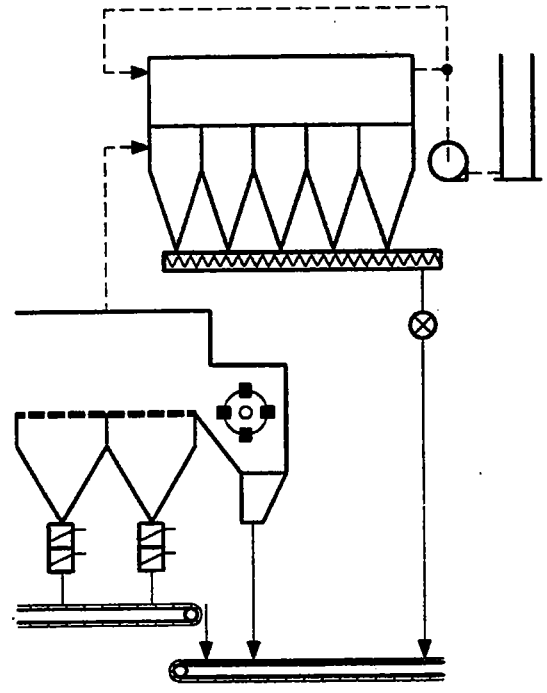

Gravel bed filter

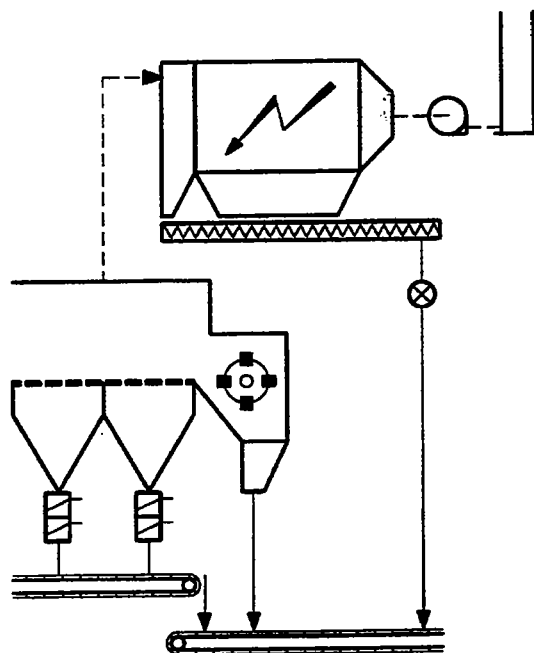

Electrostatic precipitator

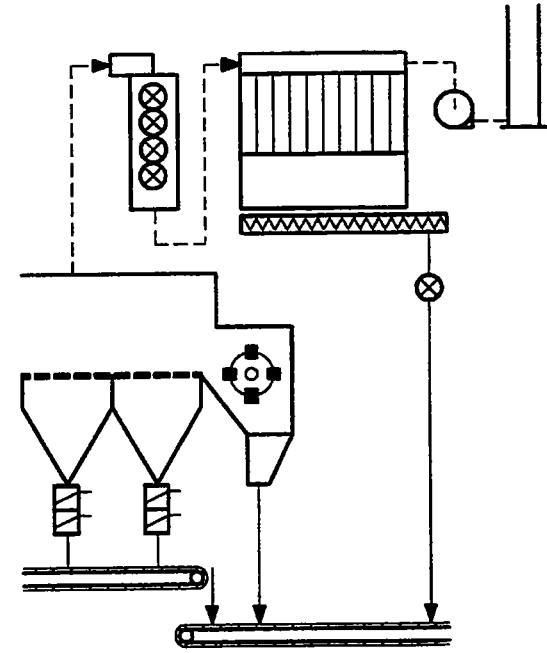

Air to air heat exchanger
and bag filter

3.1.10 Developments

Air recirculating (Duotherm) cooler

A patent has been taken out in 1970 by the "Société des Ciments Français" concerning the recirculation of the vent air after sending it through a heat exchanger.

The first application of the unconventional system has been realized in 1970 at the Beaucaire plant of the above mentioned company, on a 1500 t/d Fuller cooler.

Initial experience gained with this installation was very satisfactory.

Only few installations using this principle have been realized, e.g. in the Ulco plant. The main advantages and disadvantages of this system are:

Strengths	Weaknesses
<ul style="list-style-type: none"> • no dust emission at all • simple • low investment cost • heat recovery possible (at various temperature levels) • extension possible by adding further heat exchange units 	<ul style="list-style-type: none"> • possible wear of fan blades (preventative measures necessary) • maintenance and operating costs higher than conventional cooler dedusting system with EP

Modern cooler technology and problems in some cases have pushed this idea in the background. However, it might be reactivated if it can be combined with modern cooler systems.

Dual pass cooler

A completely new principle of cooling in a grate cooler has been introduced by Polysius in 1994: the dual pass cooler or REPOL-ZS.

This cooler can be considered a two-grate cooler with intermediate crusher where grate 1 and 2 are identical.

The hot, 1400°C clinker from the kiln is fed on top of a layer of colder clinker already laying on the cooler grate. At the end of the grate, the now cold lower clinker layer is extracted via a special system consisting of reciprocating bars and a hopper. The upper layer which has reached about 500°C passes a roller crusher and is then returned to a intermediate hopper below the kiln from where it is fed onto the empty grate to pass the cooling air a second time, this time below the fresh hot clinker.

One 1400 t/d unit is in operation in Germany using Jet-Ring technology. With less than 1.6 Nm³/kg cooling air, extremely low clinker temperatures have been reported. The crucial problems of this solution are intermediate transport and storage.

In spite of the compact size, high cooling degree with low air flow and low plate temperatures, this cooler will only be successful if the intermediate temperature level can be increased and the heat losses reduced.

Figure 20a Non venting cooler

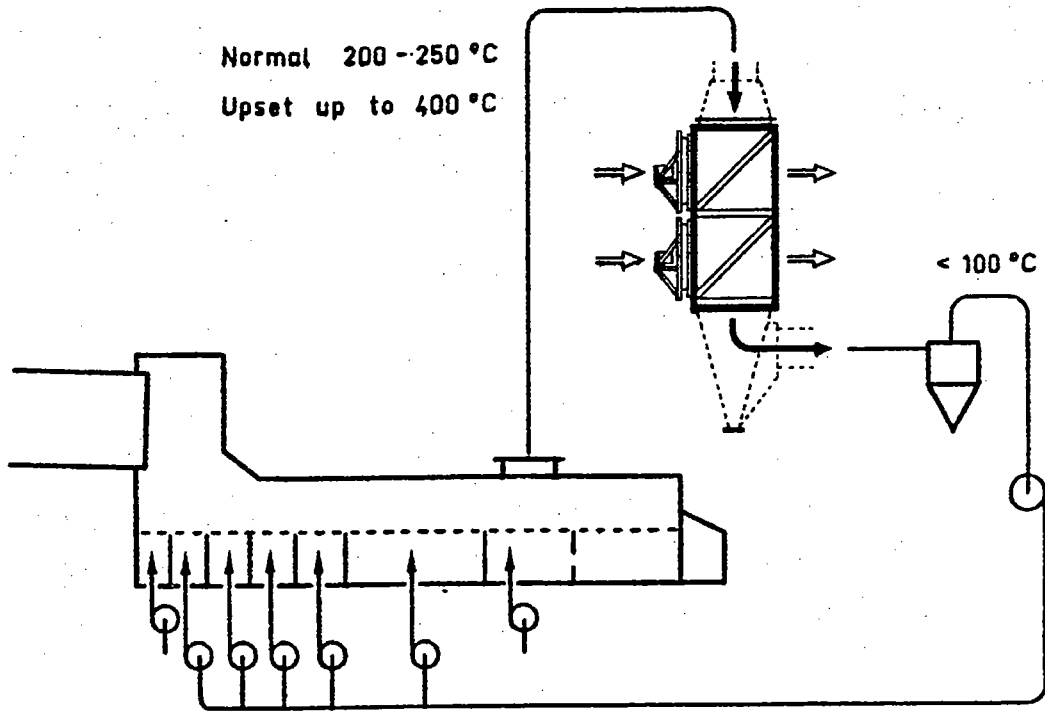
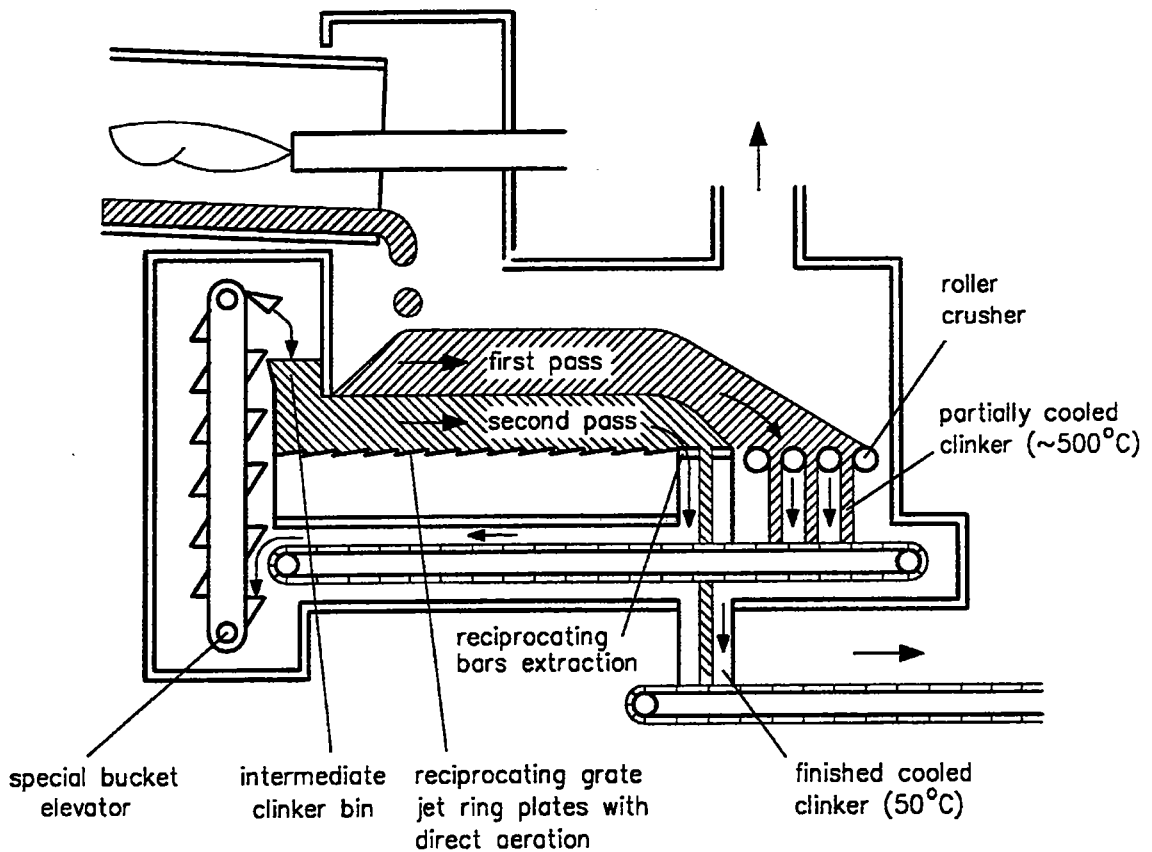

Figure 20b Dual pass cooler (Polysius)



3.2 The Cross Bar Cooler

3.2.1 Principle

F.L.Smidth and Fuller developed together the new SF (Smidth - Fuller) Cross Bar Cooler representing a completely new concept.

The basic idea was to develop a cooler in which conveying of clinker and air distribution systems are separated. The SF cooler has a clinker conveying device installed above an entirely fixed grate.

In addition the cooler should be less complicated, more efficient and easier to operate than other grate coolers on the market. Sealing air is eliminated and the distribution of air is optimized for all modes of operation

The thermal behavior of the SF cooler (e.g. heat balance, recuperation) is similar to the other grate coolers.

3.2.2 Main features

- One inclined fixed grate.
- Clinker conveying by cross bars, separate from air distribution.
- No thermal stress of grate.
- Minimum wear on grateplates due to a dead layer of clinker (50 mm) protecting the grate surface. The thickness is given by the space between the cross bars and the grate. (Anticipated service life time at least 5 years)
- Dynamic flow control unit (mechanical flow regulator) for each grate plate. The mechanical flow regulator maintains a constant airflow through the grate and clinker bed, irrespective of the clinker bed height, particle size distribution, temperature, etc.
- No fall through of clinker to the undergrate compartment.
 - Eliminating undergrate clinker transport resulting in low installation height for new plants.
- Easy cooler operation by elimination of sealing air and automatic control of air distribution.
- Modularized cooler concept → short delivery and installation time.
- Different drive speeds across the cooler possible.
 - Additional control of clinker distribution.
- Fewer and less expensive wear parts (easy to replace).
- Easy visual inspection of undergrate compartment (clean undergrate, windows).
- Sustainably high thermal cooler efficiency throughout the lifetime of the cooler.
 - Reduced system heat consumption.

Figure 21a: SF Cross Bar Cooler

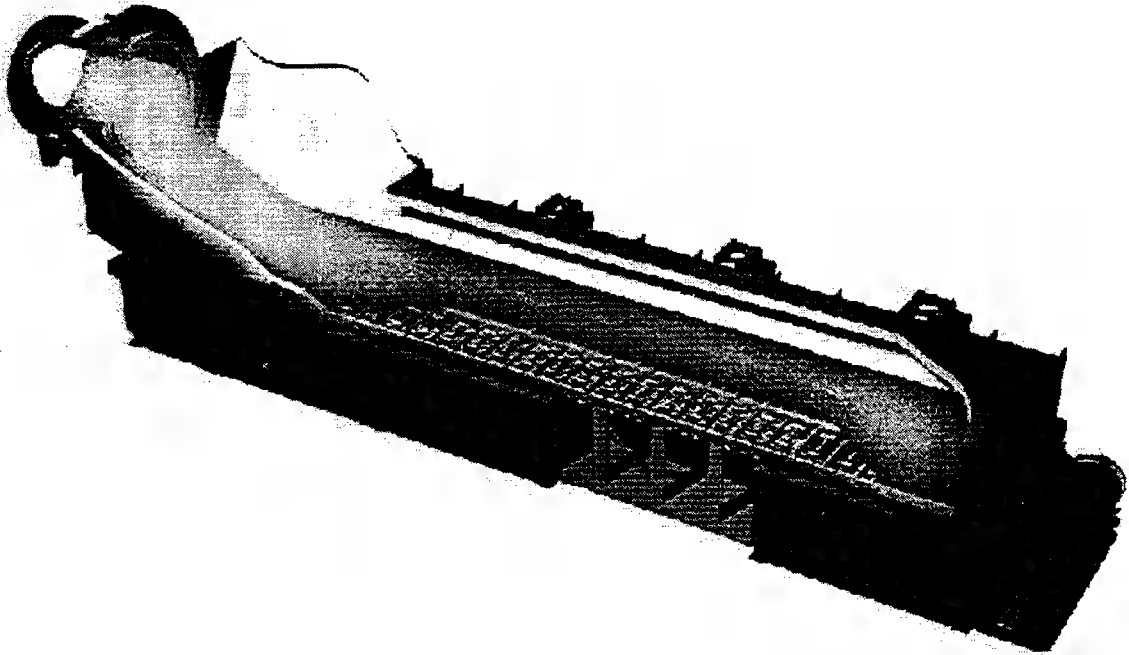

Figure 21b: SF cooler grate with cross bars



3.2.3 Strengths and Weaknesses

Strengths	Weaknesses
<ul style="list-style-type: none"> • No clinker fall through (no hoppers, no dragchain). • The grate is protected from overheating. • Very high availability is expected. • Wear and tear affects only the conveying system and not the air distribution system. • For each plate, the cooling air is individually controlled. • The amount of cooling air is about 1.6 to 1.8 Nm³/kg. • Reduced height and maintenance required since the undergrate clinker transport can be dropped. • Time for installation is short due to modular concept. 	<ul style="list-style-type: none"> • The clinker bed seems to be influenced by the conveying reciprocating cross bar, resulting in disturbed clinker layers. • In case of fine clinker and coating drops, air breakthroughs can occur. • The performance of the mechanical flow regulator (amount of cooling air) and its distribution is yet to be assessed. • Airflow through the fixed grate at the cooler inlet (CIS) can generate dust and dust cycle. <p><i>change cross bars each year</i></p>

Remark: So far, no SF Cross Bar Cooler is in use within the "Holderbank" group and therefore no first hand experience is available. Worldwide, there are only three SF cross bar coolers installed. Two of a capacity of 450 t/d and one of 2000 t/d. (as of January 1999)

Figure 22a: Cross Bars: Easy to replace wear parts



Figure 22b: Mechanical flow regulator

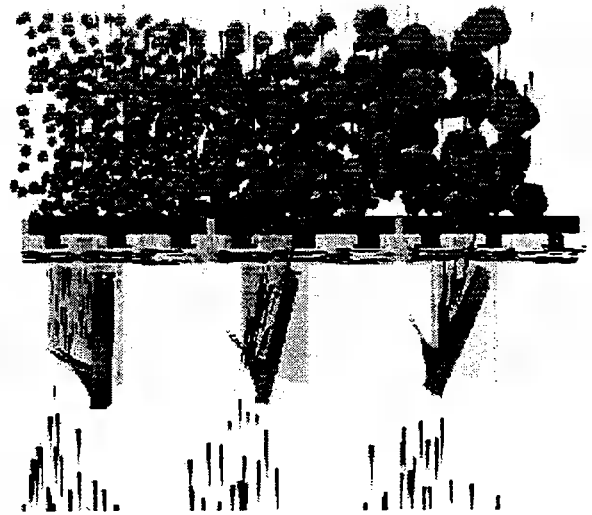
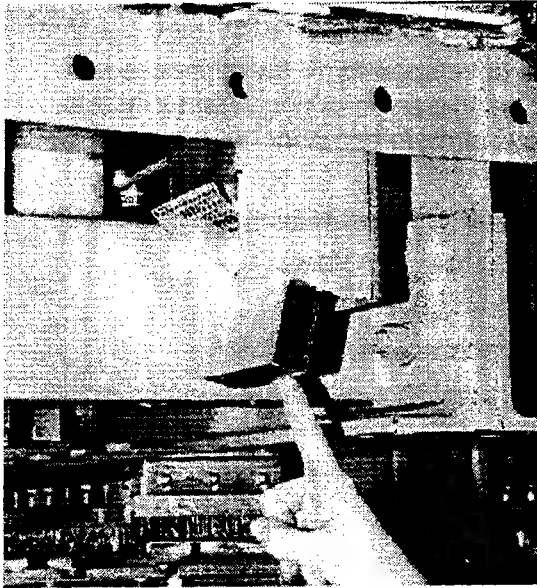
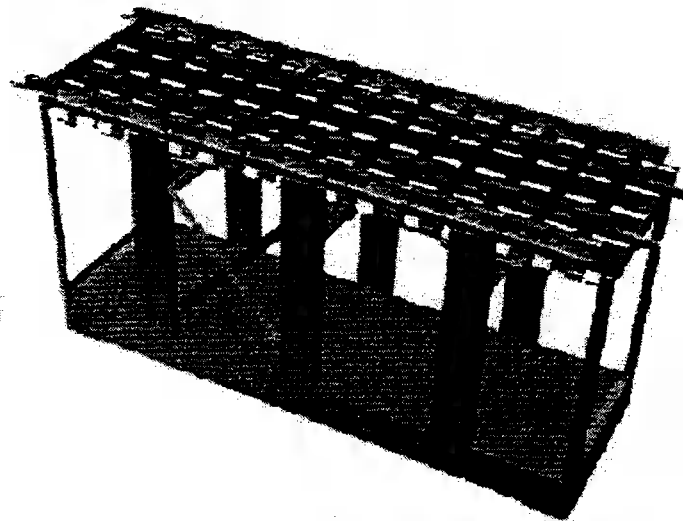

Figure 22c: Modular concept: One module



3.3 The Travelling Grate Cooler

3.3.1 Principle

The traveling grate cooler (Recupol) was originally developed by Polysius for use in combination with grate preheater (Lepol) kilns. Using the same principle and similar technology, it uses the same wear parts. The following main components can be distinguished:

- Casing with kiln hood and connections for air at different temperature levels
- Inlet with water cooled chute (2nd generation) and pulsator
- Traveling grate with return carrying idlers and drive system
- Aeration system with fans, undergrate compartments
- Riddling extraction system with chutes, flap gates, hoppers and transport
- Clinker crusher

◆ Material transport

The clinker is carried by a horizontal traveling grate which works like a stationary caterpillar chain with perforated chain plates. In contrast to the reciprocating grate cooler, the clinker does not tumble over plate edges, but remains as undisturbed layered bed from inlet to discharge.

◆ Heat exchange

Heat exchange takes place, like for the reciprocating grate according to the **cross current** principle. Because the layers remain, it should be even better, at least theoretically.

◆ Cooling air

Ambient air is blown by a number of cooling air fans to underneath of the travelling grate plates carrying the clinker. Pressure and flow criteria of cooling air are basically as for the reciprocating grate cooler.

◆ Water cooled inlet chute

In order to achieve rapid cooling in the inlet section, but also to protect the travelling grate from the highest clinker temperatures, Recupol coolers were equipped with a water cooled inlet chute.

◆ Key figures / KPI

Specific grate loading: 25 - 30 t/d m² (design)
Largest units: 3000 t/d (Lägerdorf kiln 10)

Figure 23 Travelling grate cooler

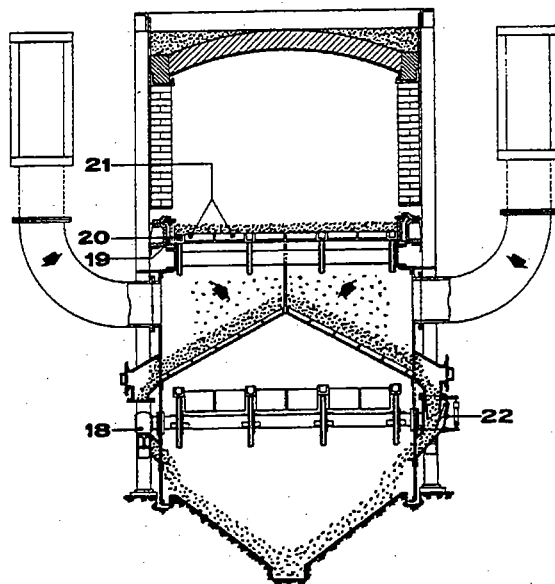
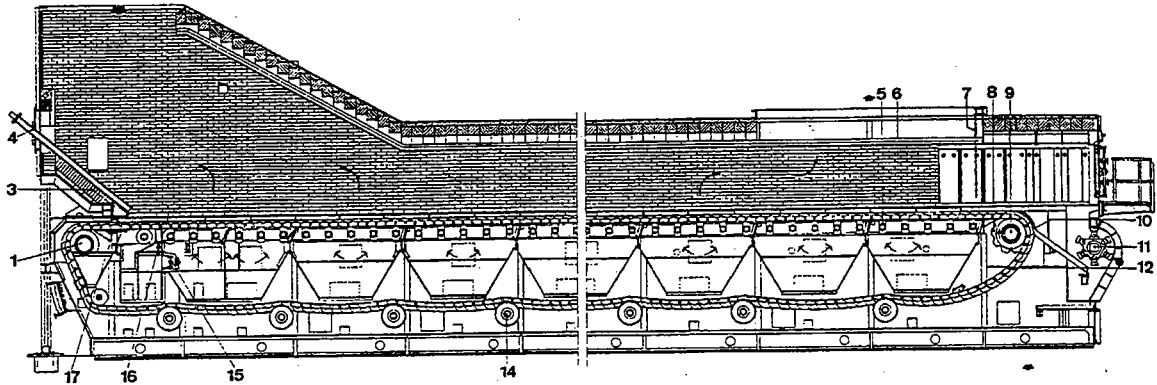

- 1 Turning shaft
- 3 Supporting girder
- 4 Water cooled steel plate
- 5 Shaft for upper traveling route
- 6 Siding plate
- 7 Chain curtain
- 8 Chain wheel
- 9 Drive shaft
- 10 Strip off grate
- 11 Clinker breaker
- 12 Grate bolt
- 14 Shaft for lower traveling route
- 15 Pulsator
- 16 Blower nozzle
- 17 Drag plate
- 18 Slide bearing
- 19 Sealing elements
- 20 Chain link
- 21 Grate plate
- 22 Flap gate

3.3.2 Strengths and Weaknesses

Travelling grate cooler compared to reciprocating coolers:

Strengths	Weaknesses
<ul style="list-style-type: none">• Possibility of replacing grate plates during operation (on the returning part)• Undisturbed, layered clinker bed is better for optimum heat exchange	<ul style="list-style-type: none">• Larger machine for the same grate area equipment requiring more space and higher civil cost• Lower specific grate loadings adding further to overall size• More expensive to build than a reciprocating grate cooler• The absence of clinker movement (see above) was often considered a disadvantage because of cases where a solid (fritted) layer on top of the clinker bed made it impermeable for air. For this reason, pulsators were installed for first cooling fans.• Much higher maintenance requirement with ageing equipment• Heat loss via cooling water for inlet chute

Due to the mentioned weaknesses, Polysius eventually decided to develop their own reciprocating grate cooler (Repol) around 1980:

Figure 24 Travelling grate cooler: Design details

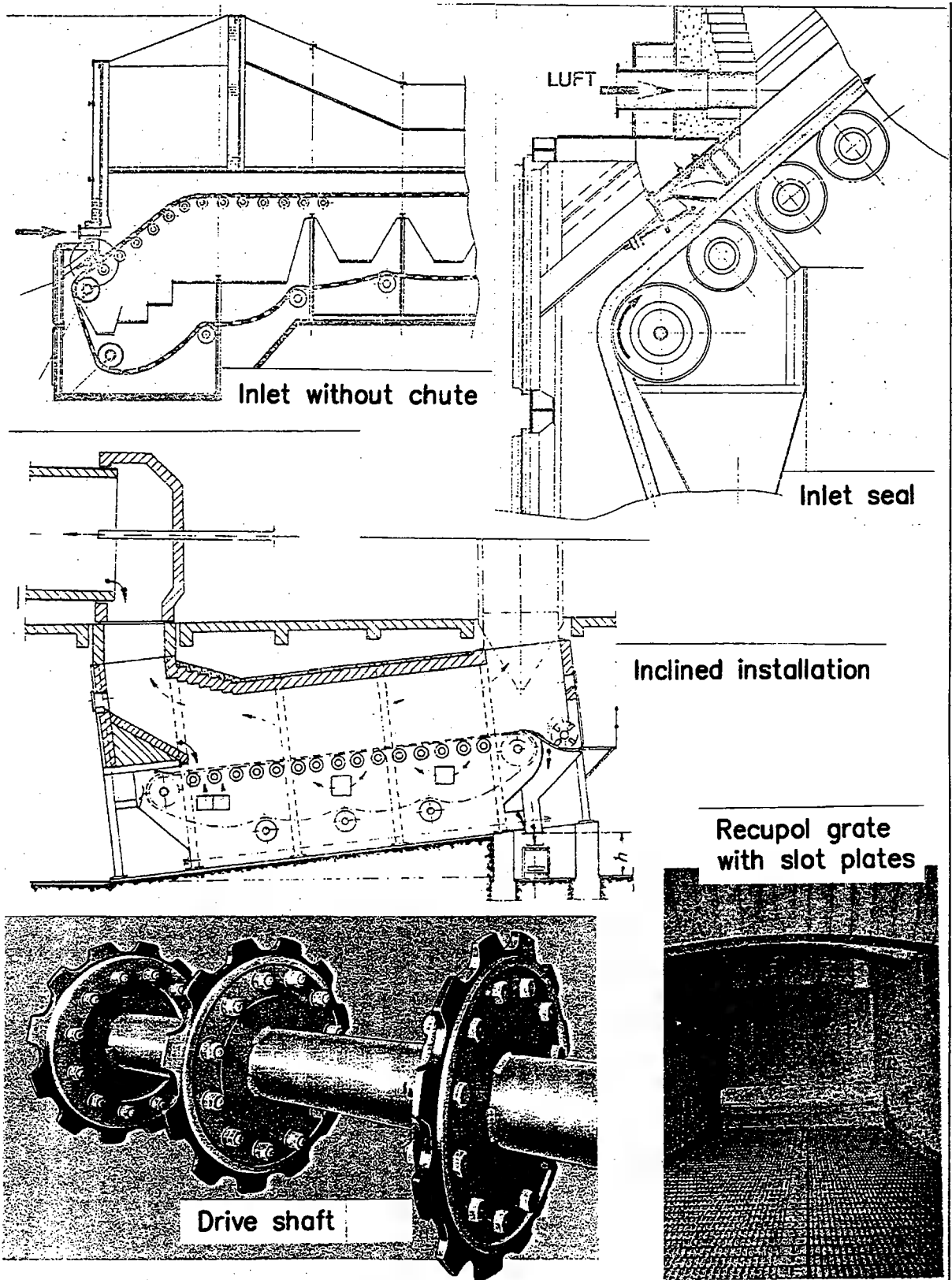

4. ROTATING COOLERS

4.1 The Rotary Cooler or Tube Cooler

4.1.1 Principle

The rotary cooler consists mainly of a rotating cylinder, similar to a rotary kiln.

The clinker is fed through the inlet chute and is then cooled by air while being transported towards the outlet end. Cooling is performed in countercurrent flow. The tube is equipped with internal lifters which improve the heat transfer. About 2/3 (66%) of the cooler length is lined with refractory bricks.

The rotary cooler is of simple design and is the oldest type of clinker coolers. It was seldom used for modern, large kiln systems. Therefore comparatively little design and operating experience is nowadays available for rotary coolers above 2000 t/d. However, the application of rotary coolers still offers certain advantages. Presently units up to 4500 t/d (dimensions dia 6.3/6.0 x 80 m) are in operation. It will be interesting to follow the future development of large rotary coolers.

4.1.2 Design Features

- ◆ **Arrangement** of the rotary cooler is normally in the extension of the kiln axis; in many cases the reverse manner (underneath the kiln) has been applied.
- ◆ The **diameter** of the cooler is similar to that of a corresponding suspension preheater kiln. Likewise the rotating speed is in the same range as for the kiln (max. 3 rpm). Length/diameter ratio: $L/D \sim 10$.

Many cooler tubes are designed with an extension in diameter in order to reduce air velocity.

- ◆ The **inclination** is comparatively high (in the order of 5%).
- ◆ Like for all rotating coolers, the **internal heat transfer equipment** is an important part of the rotary cooler. Its task is to generate additional area by scattering the clinker without generating too much dust. Basically a similar design may be applied as in a planetary cooler tube (see next chapter) however the following differences must be considered:
 - The clinker falling heights are larger. Wear protection of shell and lining is essential.
 - At a comparative length position the clinker in a rotary cooler is hotter than in a planetary cooler.

Figure 25 Rotary cooler

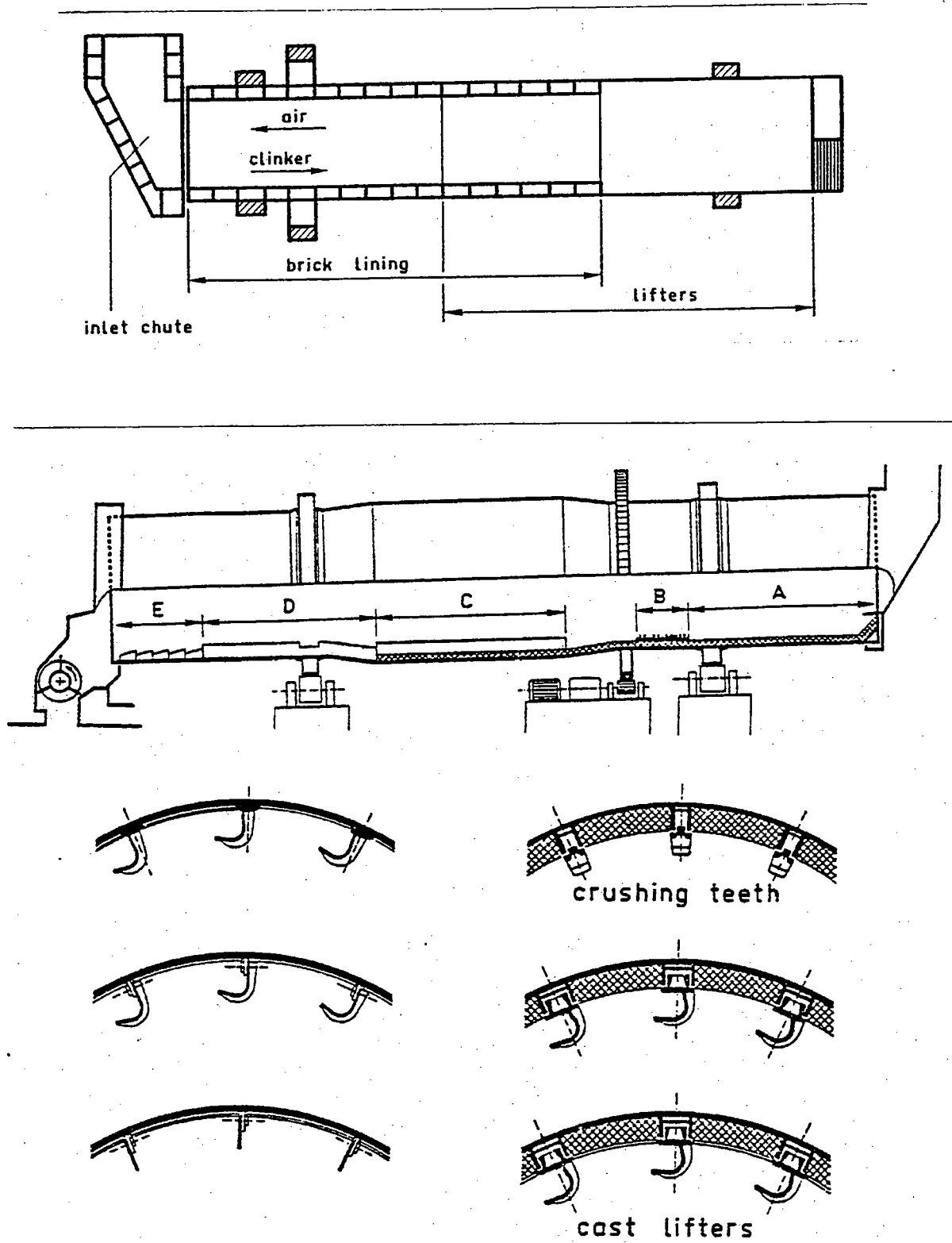

The following zones can typically be distinguished in a rotary cooler (simplified):

- A Lined inlet zone
- B Lined crushing teeth zone
(metallic teeth)
- C Lined cast lifter zone, lining protected by wearing plates
(at least in the second half)
- D Cast lifter zone, shell protected by wearing plates
(having air gap, giving also insulating effect)
- E Sheet metal zone with wearing plates

Construction materials have to be selected according to the high temperature and wear requirements.

4.1.3 Cooling performance

Depending on the design and the shape of the lifters clinker outlet temperature usually tends to be high. In many cases it is necessary to enhance the cooling by injecting water into the tube (up to 60 g/kg clinker) in order to reach reasonably low clinker temperatures of 100° to 150°C.

The cooling efficiency (heat recuperation) is equal or even slightly better than on a planetary cooler.

4.1.4 Strengths / Weaknesses

Strengths	Weaknesses
<ul style="list-style-type: none"> • Simplicity of cooler design, robust piece of equipment. • No special mechanical problems comparable to a rotary kiln. • No control loops. • Easy commissioning. • No waste air and therefore no dedusting equipment required • Electrical energy consumption up to 5 kWh/t lower compared to grate cooler. • Rotational speed can be adjusted and therefore upset kiln conditions can be handled easier than with a planetary cooler. • Suitable for AS type precalcining system tertiary (extraction of hot air is possible). 	<ul style="list-style-type: none"> • Not recommended for large units (above 2000 t/d) • Formation of build-ups ("snowmen") in the inlet chute. A water-cooled chute or a dislodging device is required in such case. • Clinker outlet temperatures tend to be high and therefore water injection is usually required. • Due to large falling height wear protection in the tube must be reinforced (compared to a planetary cooler). • High kiln foundations are required. • Cooler inlet seal can contribute to additional false air inlet.

Figure 26 Internal transfer equipment for rotary and planetary coolers

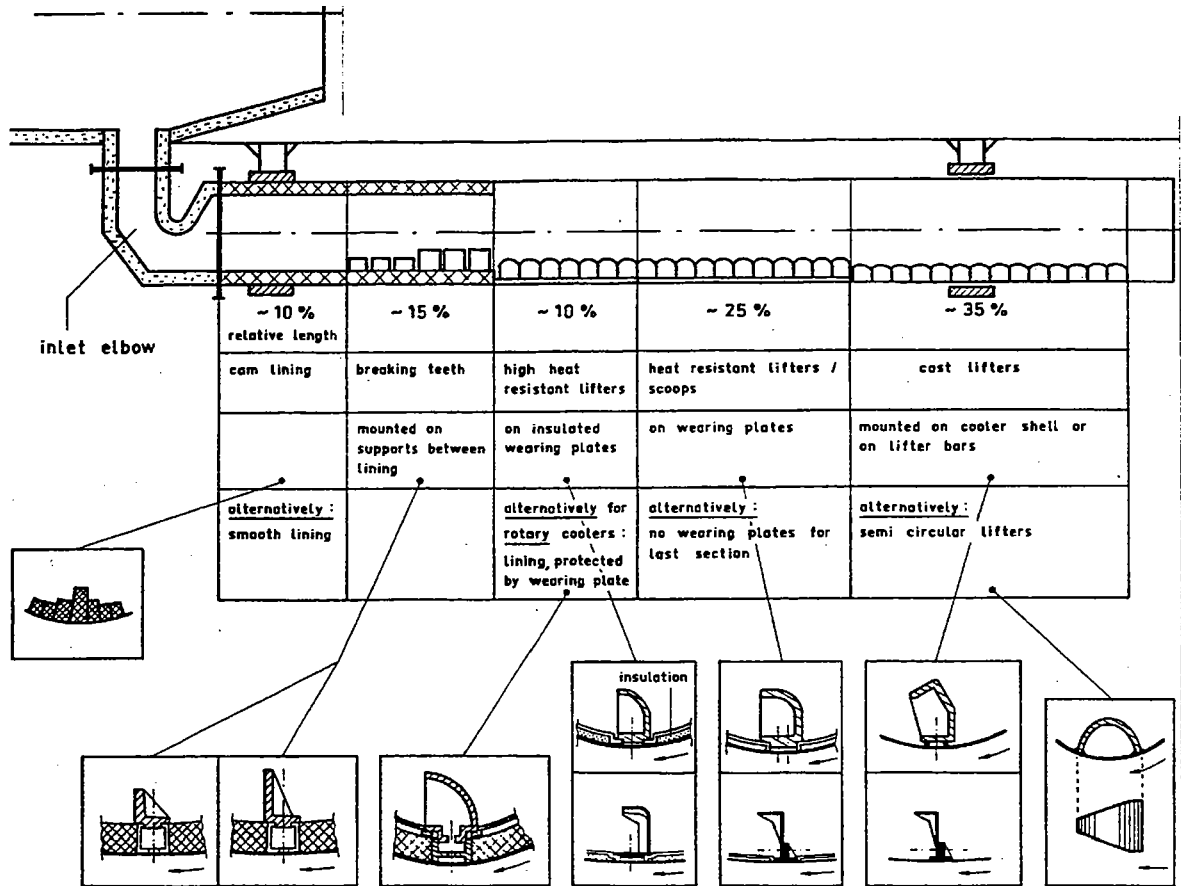

4.2 The Planetary Cooler

4.2.1 Principle

The planetary cooler is based on the same cooling principle as the rotary cooler in the preceding chapter. However, the essential difference of a planetary cooler is the number of individual cooling tubes. The flow of clinker is subdivided into 9 to 11 (usually 10) cooling tubes which are installed around the kiln circumference at the kiln outlet (see Fig. 15). Therefore the planetary tubes follow the kiln rotation. Because of their connection to the kiln rotation, planetary coolers do not need a separate drive. This fact already illustrates one main advantage of the planetary cooler: its simplicity in operation.

Strictly speaking the cooling of clinker does not only start in the cooling tubes but already in the kiln. In the case of a planetary cooler the kiln burner pipe is always inserted into the rotary kiln so that a cooling zone behind the flame of 1.5 to 2.5 kiln diameters is created. This zone is called the "kiln internal cooling" zone and must be considered as an integral part of any planetary cooler. In this zone the temperature of the clinker drops from 1450° to 1200 - 1300°C. This temperature reduction is important for the protection of the inlet opening, the elbow and the first section of the cooling tubes.

After this first cooling in the kiln internal cooling zone the clinker falls into the elbows when they reach their lowest point of kiln rotation. The hot clinker is then cooled by air in counterflow (the amount of air equals the amount of secondary air). The air is heated up to approx. 700°C. The clinker reaches final temperatures which are typically in the range of 140° to 240°C.

A considerable amount of heat is also transferred to ambient by radiation and convection since approx. 75% of the cooler shell is not insulated.

4.2.2 Historical

Planetary coolers have been used since 1920. When large kiln units and grate coolers were developed planetary coolers were abandoned for many years. But about 1966 planetary coolers of large capacities were introduced. At that stage serious mechanical problems occurred on these first large planetary coolers. As a consequence a lot of work had to be done in order to improve the mechanical design of planetary coolers. As a result of extensive computer calculations and operating experience the planetary cooler became a mechanically reliable piece of equipment.

In the late 1970's, the design had reached a high standard and a considerable level of perfection. Units of up to 5000 t/d were envisaged. With the demand for permanently larger units using precalciner technology with separate tertiary air dusts, the boom period of the planetary coolers came to an end.

Figure 27 Planetary cooler

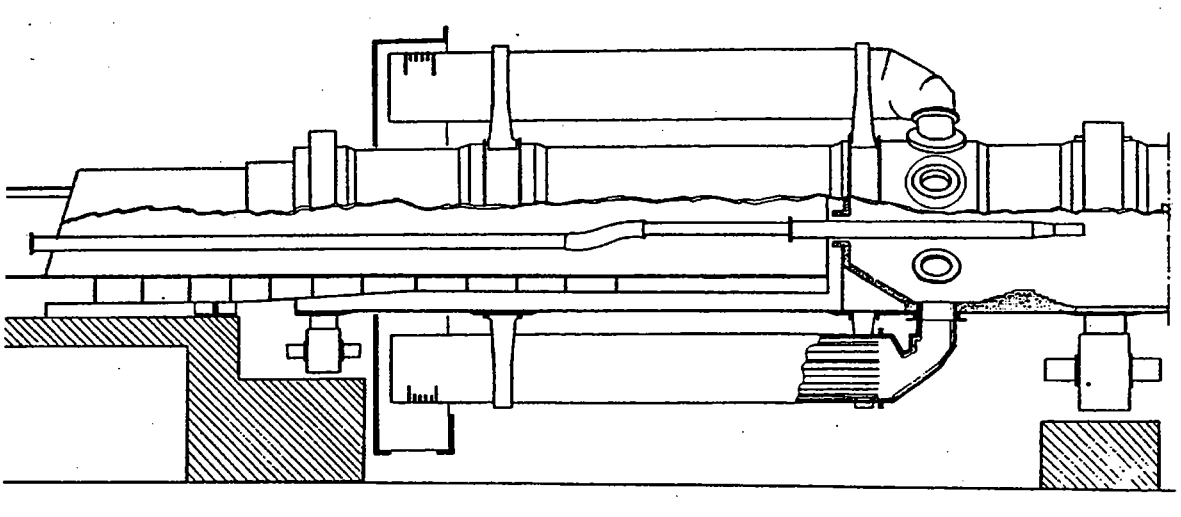

4.2.3 Design features

Planetary coolers in the late 1970's had the following design features:

- ◆ **Shell extension:**
The kiln shell is extended beyond the cooling tube outlets and is supported by an additional roller station.
- ◆ **Fixation of cooling tubes:**
Fixed support of cooling tubes near inlet and loose support near outlet end.

With larger coolers, the cooling tubes can consist of two separate sections requiring three supports. In that case two fixed supports are located near inlet and near outlet and a loose support is located at the interconnection point in the middle.

- ◆ **Design of cooler supports:**
The kiln shell is reinforced (high thickness) where the cooler support structure for the cooler is welded on. The support structure (base and brackets) itself is of heavy design consisting of reinforcement ribs and box beams.
- ◆ **Cooler length:**
Length/diameter ratio of tubes is approx. 10:1
- ◆ **Inlet openings:**
The inlet openings to the cooler elbows weaken the kiln shell and high mechanical and thermal stresses occur in that zone.
The openings are made of oval shape and the kiln shell is considerably reinforced in its thickness (up to 140 mm in large kilns) in order to compensate for the weakening.
In some cases a diagonal retaining bar (made of high heat resistant steel) is incorporated in the opening in order to avoid that large lumps can enter the cooler.
- ◆ **Kiln-to-elbow joint:**
This joint is designed in a manner that no forces due to thermal expansion and deformation are transmitted from elbow to kiln.
- ◆ **Elbow:**
In order to prevent that clinker is falling back into the kiln while the opening is on top position, the position of the cooling tube is displaced back against the direction of rotation. The elbow design must avoid excessive dust backspillage and wear.

4.2.4 Internal heat transfer equipment (see Fig. 26)

Cooling performance depends strongly on efficient lifters of solid and durable design. Since high heat resistant metallic lifters are available on the market also the high temperature zones can be adequately equipped. Special high temperature alloys can be used for this purpose. They can withstand maximum temperatures of up to 1150°C. These alloys are usually characterized by a high chromium content of approx. 30% Cr. Other elements as Ni or Mo can occur in various proportions. Fig. 26 shows a typical arrangement of heat transfer internals. Breaking teeth are applied in the hottest zone. They are able to crush large lumps of clinker and create also a tumbling effect, which improves the heat transfer. They are of heavy design and mounted on separate supports.

The first rows of lifters must be carefully selected regarding design and material. Their functioning is very important since they also protect the following lifters from overheating.

Figure 28a Temperature profile in planetary cooler

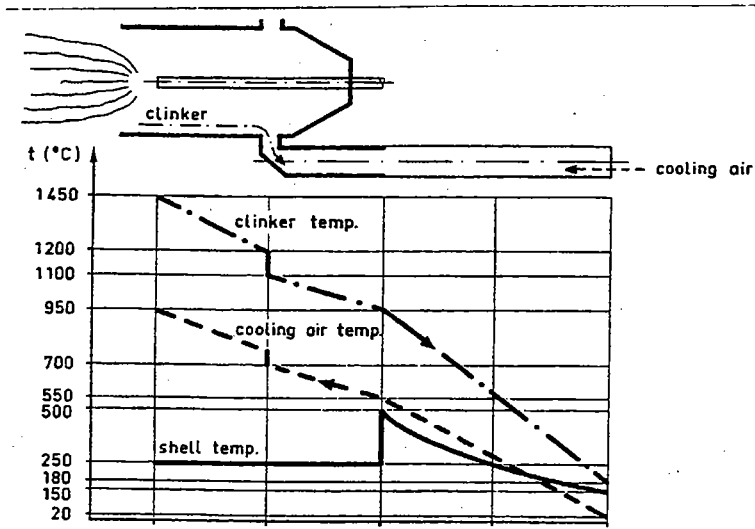
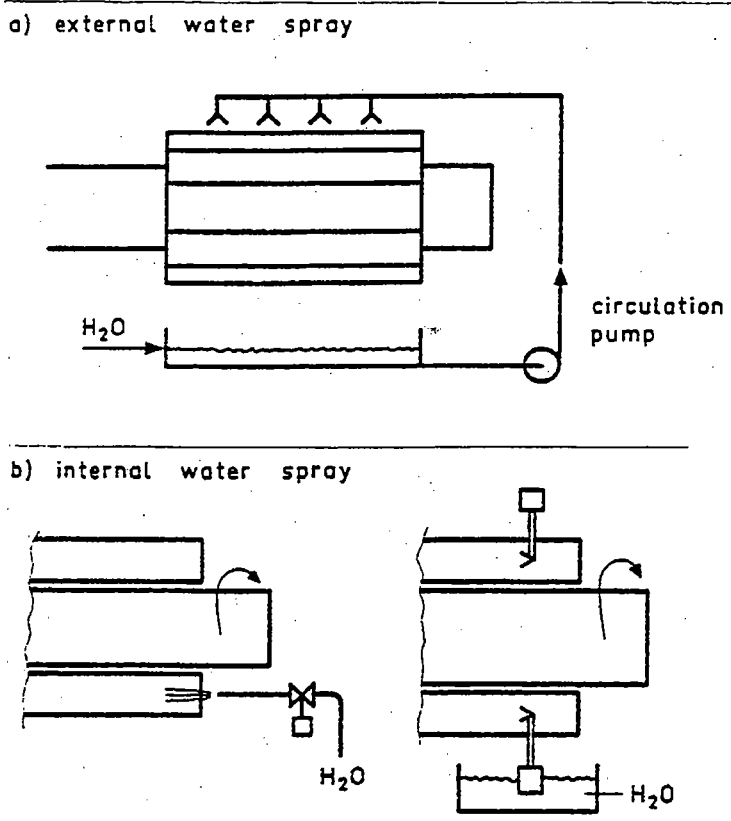

Figure 28b Water cooling for planetary coolers



5. VERTICAL COOLERS

5.1 The Gravity Cooler (G - Cooler)

The Claudius Peters Company have developed the “g-cooler”. The letter “g” stands for gravity since clinker movement is performed by gravity.

This cooler is designed as an after cooler and can therefore only be used in connection with a primary cooler such as a short grate cooler or a planetary cooler. The installation together with a grate cooler is shown in Fig. 29.

An intermediary crusher reduces the clinker size to 20 - 30 mm. The material of approx. 400°C is then filled by a drag chain into a vertical shaft. Cooling is performed by horizontal rows of tubes which are cooled by internal air flow. The heat is therefore exchanged indirectly and the air remains dust-free. The clinker slowly drops down (at a speed of 20 – 30 mm/s) and reaches final temperatures of approx. 100°C at the discharge.

There is no dedusting equipment required for the cooling air. However, the system according to Fig. 29 as a whole is usually not free from dusty waste air. In case of a suspension preheater kiln system there is still some waste air required on the grate cooler since the kiln cannot take all the hot air produced during the first cooling step. In addition, a marginal amount of dusty air is produced by the g-cooler itself (top and discharge).

The application of this cooler type is often considered for kiln extension projects. If an existing grate cooler (or a planetary cooler) has to be operated at higher capacity the new clinker outlet temperature can become too high. In this case the clinker temperature can be reduced by a g-cooler used as an aftercooler.

5.2 The Shaft Cooler

A shaft cooler can be operated waste-air-free and theoretically offers an ideal countercurrent heat exchange and thus high recuperating efficiency. Based on the idea the first large shaft cooler was designed and constructed on a 3000 t/d kiln in 1973.

The experience gained in the plant shows that it is possible to operate such equipment but some serious disadvantages have to be taken into account:

- ◆ All depends of the clinker granulometry! Theoretically, an extremely uniform clinker granulometry having no fines and no coarse material would be required. This is hardly achievable in a cement kiln. Therefore, fluctuations occur.
- ◆ High cooling air quantity (= secondary air) of 1.05 Nm³/kg cli is required but even so the clinker exit temperature of 350°C is very high.
- ◆ High power consumption (10 kWh/t)

For the above reasons, the technical realization is not yet solved. The shaft cooler so far is not a reasonable alternative to the conventional clinker coolers.

Figure 29 Gravity cooler (g-cooler, CPAG)

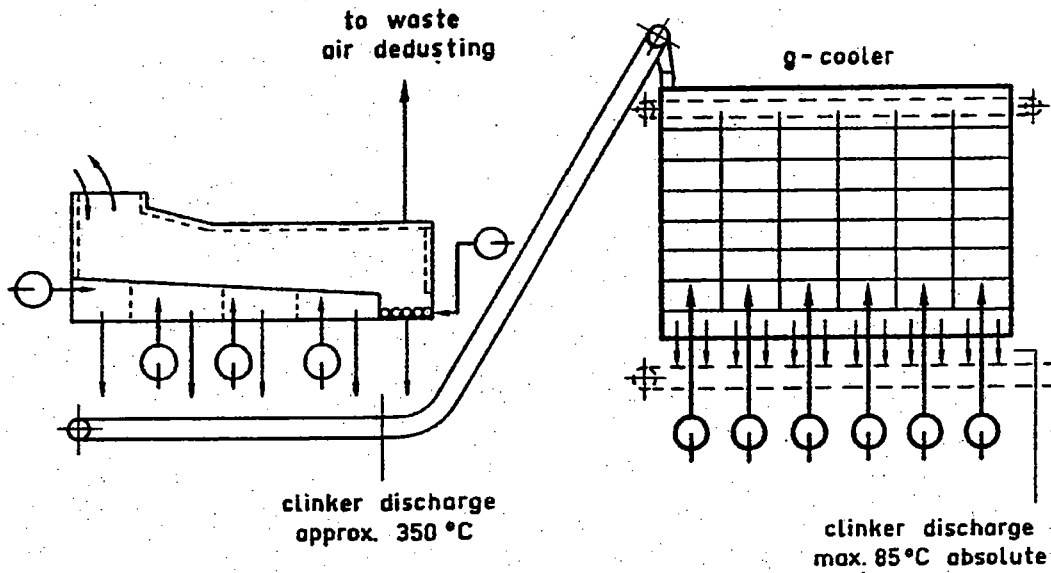

Figure 30 Shaft cooler

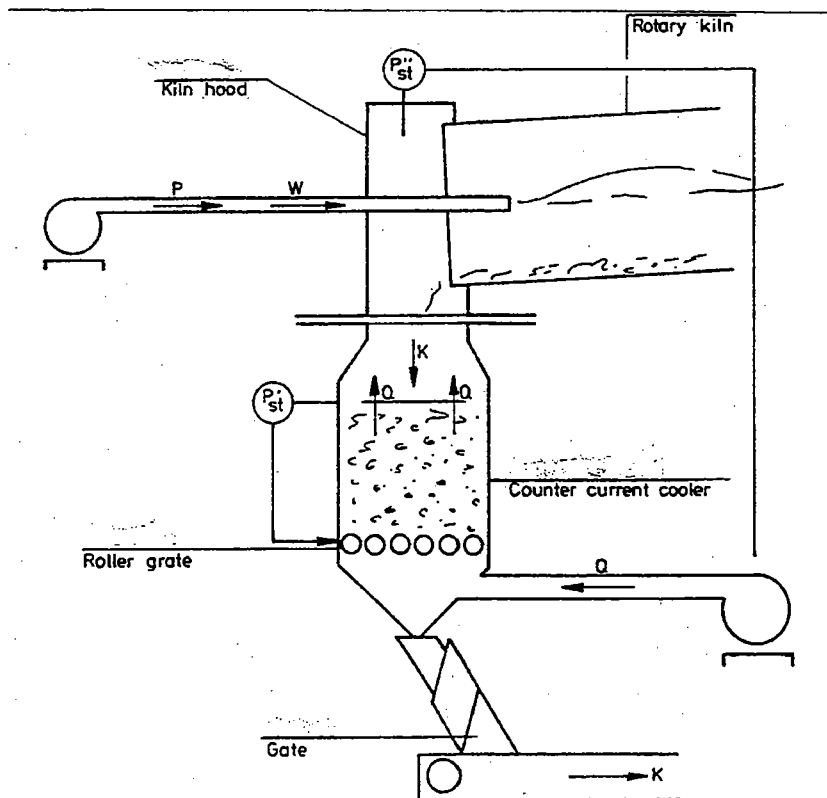

Figure 31 Claudius Peters CPAG: Combi Cooler

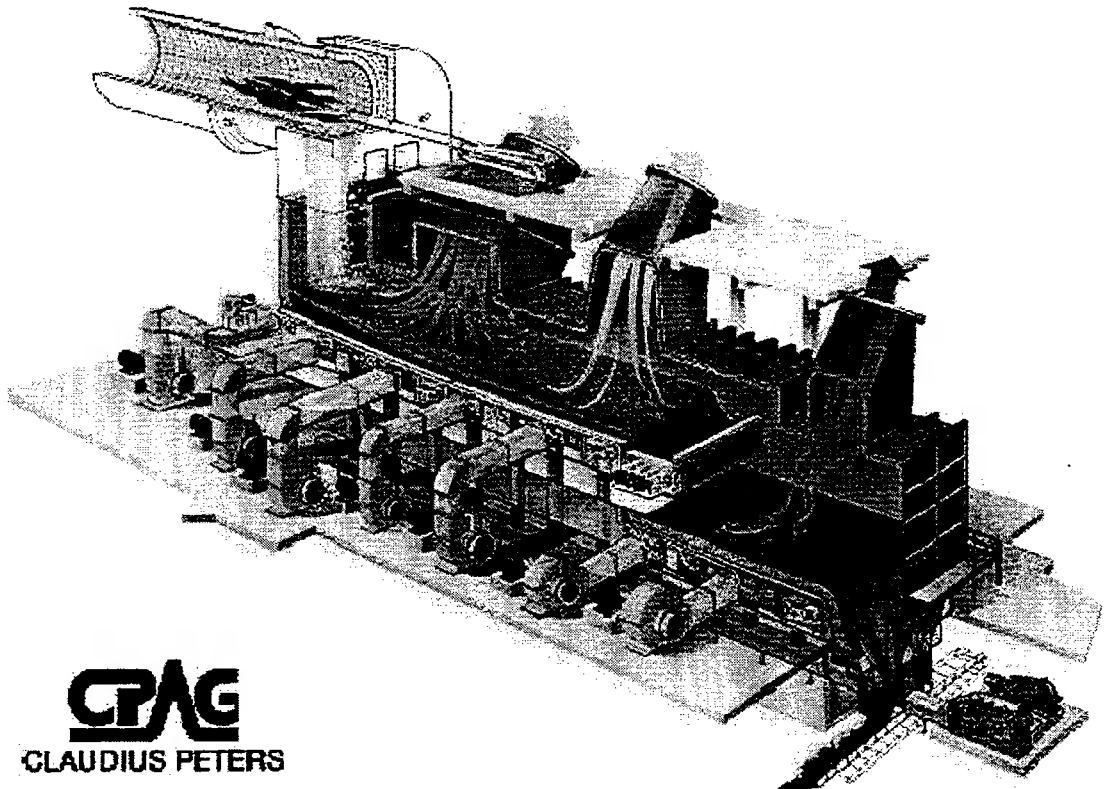

Figure 32 FLS: Coolax Grate Cooler

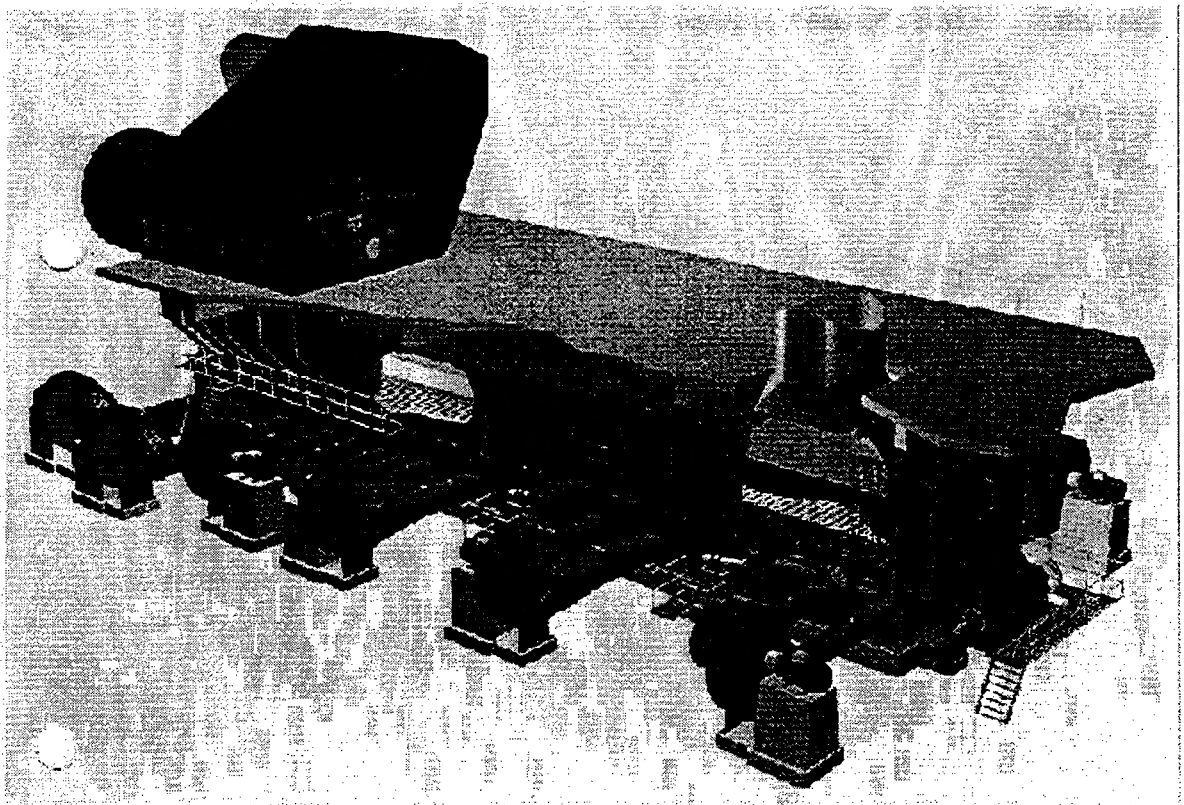

Figure 33 Fuller: Controlled Flow Grate (CFG) Cooler

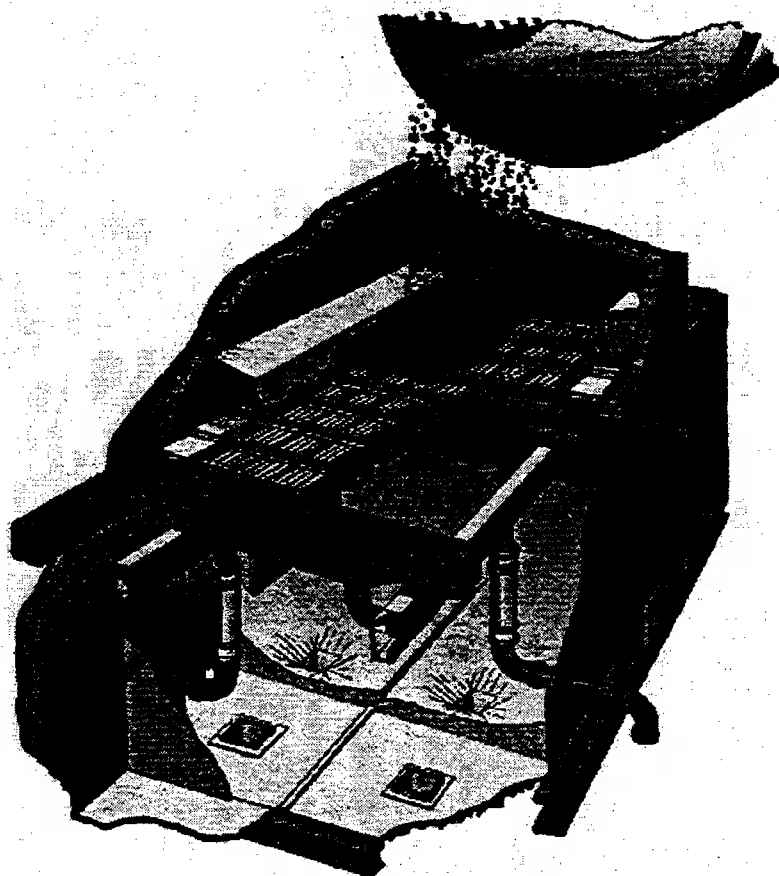

Figure 34 IKN: Pendulum Cooler

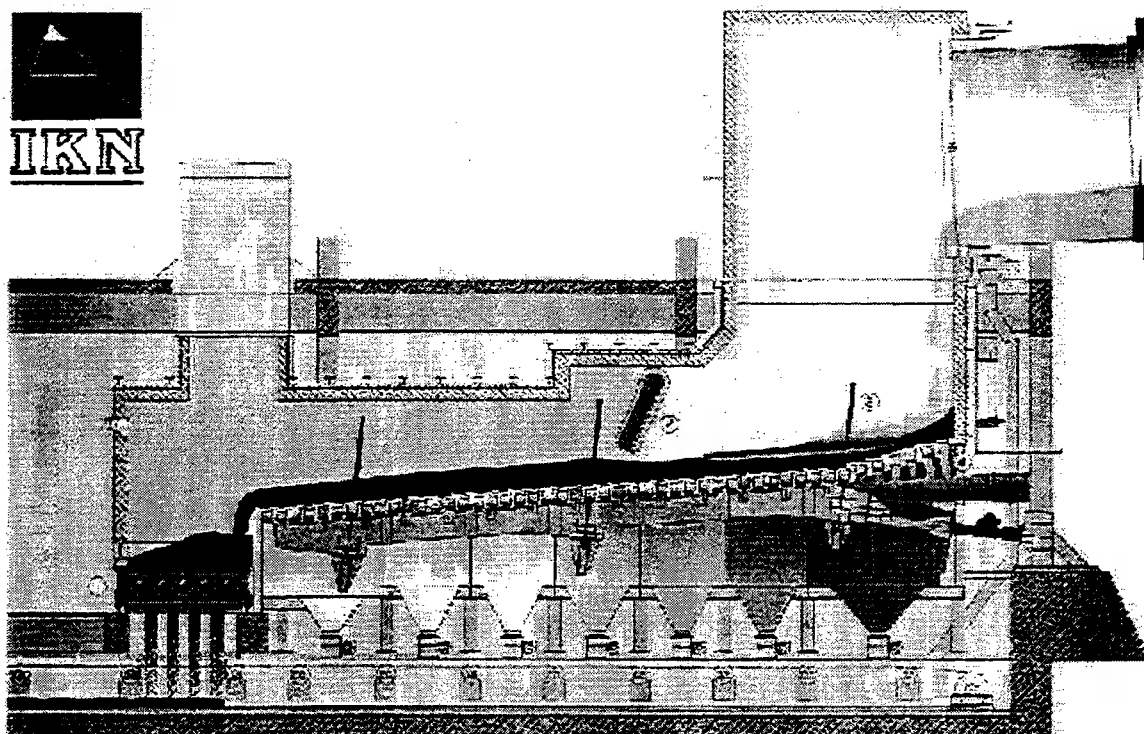

Figure 35 KHD: Pyrostep Cooler

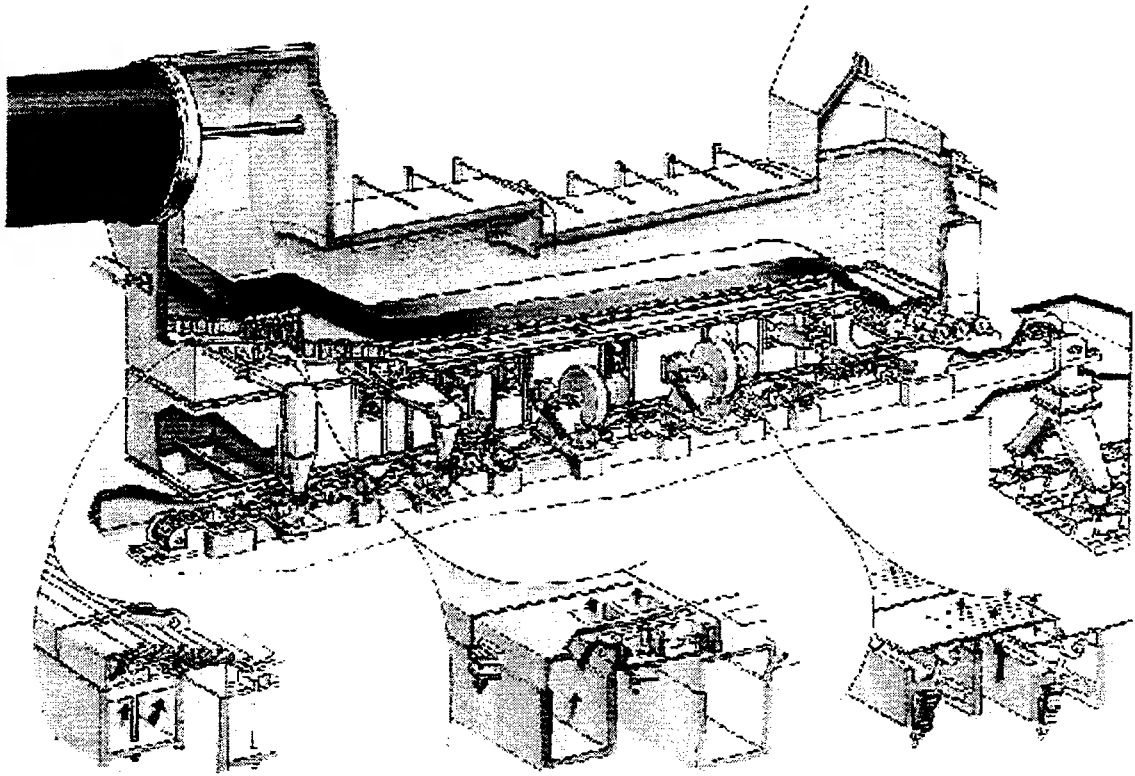

Figure 36 Polysius: Repol RS Cooler

